

## Temperature Difference Controller

# SR 14

Installation and operating instructions  
applies to SR14 versions V1, V2, V3, V4

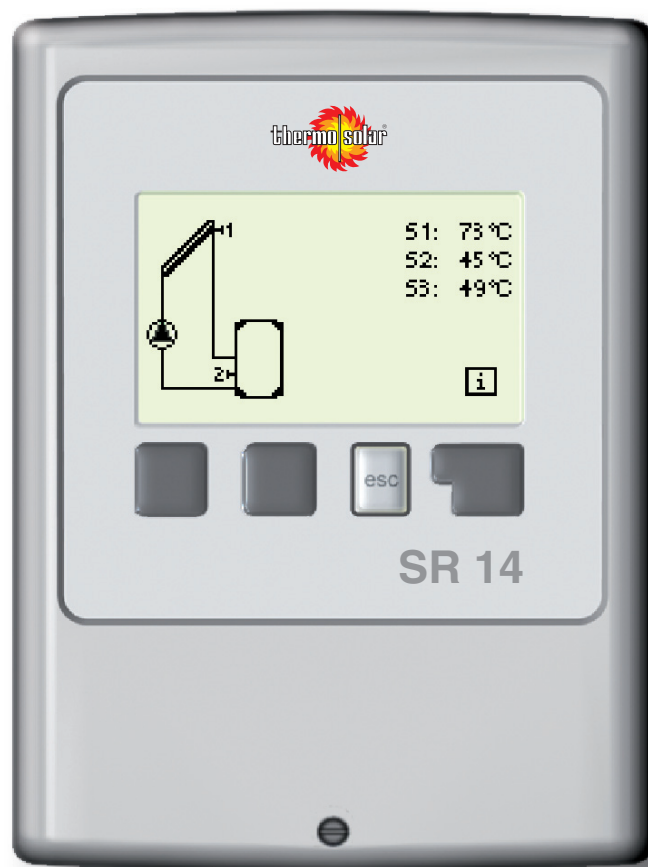

**Read carefully before installation, commissioning and operation**

# Content

A.1. - EC declaration of conformity	4	<b>7. - Special functions</b>	<b>33</b>
A.2. - General instructions	4	7.1. - Program selections	33
A.3. - Explanation of symbols	4	7.2. - Signal V1	33
A.4. - Changes to the unit	5	7.2.1. - Type of signal	34
A.5. - Warranty and liability	5	7.2.2. - Profile	34
		7.2.3. - Output Signal	34
B.1. - Specifications	6	7.2.4. - PWM off	35
B.2. - Temperature resistance table for Pt1000 sensors	6	7.2.5. - PWM on	35
B.3. - About the controller	7	7.2.6. - PWM Max	35
B.4. - Versions	7	7.2.4 - 0-10V off	35
B.5. - Scope of supply	8	7.2.5 - 0-10V on	35
B.6. - Disposal and pollutants	8	7.2.6 - 0-10V Max	35
B.7. - Hydraulic variants	9	7.2.7. - Speed when „On“	36
		7.2.8. - Show signal	36
C.1 Wall installation	10	7.3. - Speed control	38
C.2 Electrical connection	11	7.3.1. - Speed control mode	38
C.3 Installing the temperature sensors	13	7.3.2. - Purging time	39
		7.3.3. - Sweep time	39
D Terminal connection diagrams	14	7.3.4. - max. speed	39
		7.3.5. - min. speed	39
E.1 Display and Input	19	7.3.6. - Setpoint	39
E.2 Parametrisation	20	7.4. - Time and Date	40
E.3 Free commissioning	20	7.5. - Sensor calibration	40
E.4 Menu sequence and menu structure	21	7.6. - Commissioning	40
		7.7. - Factory settings	40
<b>1. - Measurement values</b>	<b>22</b>	7.8. - Heat quantity	41
		7.8.1. - Heat metering	41
<b>2. - Statistics</b>	<b>23</b>	7.8.2. - AF type	41
2.1. - Operating hours	23	7.8.3. - Glycol portion	41
2.2. - Average temperature difference $\Delta T$	23	7.8.4. - Flow rate	41
2.3. - Heat output	23	7.8.5. - $\Delta T$ Offset	41
2.4. - Graphic overview	23	7.9. - Starting aid	42
2.5. - Message log	23	7.10. - Daylight saving time	42
2.6. - Reset / clear	23		
		<b>8. - Menu lock</b>	<b>43</b>
<b>3. - Display mode</b>	<b>24</b>		
3.1. - Schematic	24	<b>9. - Service values</b>	<b>44</b>
3.2. - Overview	24		
3.3. - Alternating	24	<b>10. - Language</b>	<b>44</b>
3.4. - Eco Mode	24	Z.1 Malfunctions with error messages	45
		Z.2 Replacing the fuse	46
<b>4. - Operating modes</b>	<b>25</b>	Z.3. Maintenance	47
4.1. - Automatic	25		
4.2. - Manual	25		
4.3. - Off	25		
<b>5. - Settings</b>	<b>26</b>		
<b>6. - Protective functions</b>	<b>29</b>		
6.1. - Seizing protection	29		
6.2. - Frost protection	29		
6.3. - System protection	30		
6.4. - Collector protection	30		
6.5. - Col.- Alarm	30		
6.6. - Recooling	31		
6.7. - Anti-Legionella	32		

**This manual applies to the following hardware versions:**

**SR14 Version 1**

3 temperature sensor inputs  
1 relay output 230AC (on/off)

**SR14 Version 2**

3 temperature sensor inputs  
1 electronic relay output 230AC (for speed control of standard pumps)

**SR14 Version 3**

3 temperature sensor inputs  
1 relay output 230AC (on/off)  
1 PWM/0-10V output (for speed control of high efficiency pumps)

**SR14 Version 4**

3 temperature sensor inputs  
1 electronic relay output 230AC (for speed control of standard pumps)  
1 PWM/0-10V output (for speed control of high efficiency pumps)

**When you are unsure which version you have, check the type label on the side of the controller.**

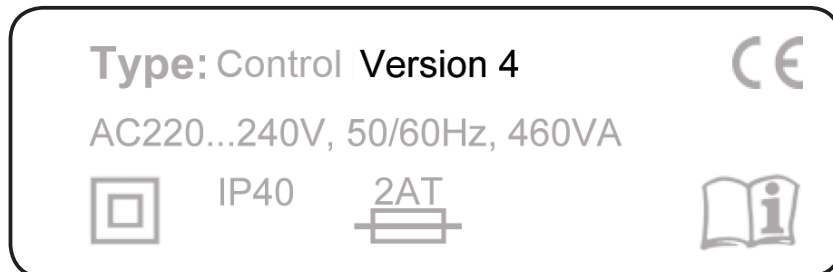

**If the version is not readable here, open the controller's "Service values" menu. The version is shown in the first line of the service values.**

# Safety instructions

## A.1. - EC declaration of conformity

By affixing the CE mark to the unit the manufacturer declares that the SR14 conforms to the following relevant safety regulations:

- EC low voltage directive 2006/95/EC
- EC electromagnetic compatibility directive 2004/108/EC

Conformity has been verified and the corresponding documentation and the EC declaration of conformity are kept on file by the manufacturer.

## A.2. - General instructions

### It is essential that you read this!

These installation and operating instructions contain basic instructions and important information regarding safety, installation, commissioning, maintenance and the optimal use of the unit. Therefore these instructions must be read completely and understood by the installation technician/specialist and by the system user before installation, commissioning and operation of the unit.

The valid accident prevention regulations, the regulations of the local power utility, the applicable standards and the installation and operating instructions of the additional system components must also be observed. The controller does not under any circumstances replace any safety devices to be provided by the customer!

Installation, electrical connection, commissioning and maintenance of the unit may only be carried out by specialists with the appropriate qualification.

**For the user:** Make sure that the specialist gives you detailed information on the function and operation of the controller. Always keep these instructions in the vicinity of the controller.

## A.3. - Explanation of symbols



Failure to observe these instructions can result in danger to life from electric voltage.



Failure to observe these instructions can result in serious damage to health such as scalding, or even life-threatening injuries.



Failure to observe these instructions can result in destruction of the unit or the system, or damage to the environment.



Information which is especially important for the function and optimal use of the unit and the system.

# Safety instructions

## A.4. - Changes to the unit



Changes to the unit can compromise the safety and function of the unit or the entire system.

- Changes, additions to or conversion of the unit are not permitted without the written permission from the manufacturer
- It is likewise not permitted to install additional components that have not been tested together with the unit
- If it becomes clear that safe operation of the unit is no longer possible, for example because of damage to the housing, then turn the controller off immediately
- Any parts of the unit or accessories that are not in perfect condition must be exchanged immediately
- Use only original spare parts and accessories from the manufacturer
- Markings made on the unit at the factory must not be altered, removed or made illegible
- Only the settings actually described in these instructions may be made on the controller

## A.5. - Warranty and liability

The controller has been manufactured and tested with regard to high quality and safety requirements. The unit is subject to the statutory guarantee period of two years from the date of sale.

The warranty and liability shall not include, however, any injury to persons or material damage that is attributable to one or more of the following causes:

- Failure to observe these installation and operating instructions
- Improper installation, commissioning, maintenance and operation
- Improperly executed repairs
- Unauthorised structural changes to the unit
- Installation of additional components that have not been tested together with the unit
- Any damage resulting from continued use of the unit despite an obvious defect
- Failure to use original spare parts and accessories
- Use of the device for other than its intended purpose
- Operation above or below the limit values listed in the specifications
- Force majeure

# Description of controller

## B.1. - Specifications

Mains voltage	230AC +/- 10%
Mains frequency	50 - 60Hz
Power consumption	~ 1.5VA
Internal fuse	2A slow blow 250V
Protection category	IP40
Protection class	II
Overvoltage Category	II
Degree of Pollution Category	II

	Vers.1	Vers.2	Vers.3	Vers.4
mechanical relay 460VA for AC1 / 460W for AC3	1	-	1	-
electronic relay min.5W...max.120W for AC3	-	1	-	1
0-10V output, tolerance 10%, 10 k $\Omega$ load or PWM output freq. 1 kHz, level 10 V	-	-	1	1
PT1000 sensor input measuring range -40°C to 300°C	3	3	3	3

### Permissible cable length of sensors and appliances:

sensor S1 (e.g. collector sensor)	<30m
sensors S2 and S3 (e.g. storage sensor)	<10m
PWM / 0...10V	<3m
electronic relay	<3m
mechanical relay	<10m

### Permissible ambient conditions:

Ambient temperature	
- for controller operation	0°C...40°C
- for transport/storage	0°C...60°C
Air humidity	
- for controller operation	max. 85% rel. humidity at 25°C
- for transport/storage	no moisture condensation permitted

### Other specifications and dimensions

Housing design	2-part, ABS plastic
Installation methods	Wall installation
Overall dimensions	115mm x 86mm x 45mm
Aperture installation dimensions	108mm x 82mm x 25.2mm
Display	Fully graphical display, 128 x 64 dots
Operation	4 entry keys

## B.2. - Temperature resistance table for Pt1000 sensors

°C	0	10	20	30	40	50	60	70	80	90	100
$\Omega$	1000	1039	1077	1116	1155	1194	1232	1270	1308	1347	1385

# Description of controller

## B.3. - About the controller

The Temperature Difference Controller SR14 facilitates efficient use and function control of your solar or heating system. The device is impressive most of all for its functionality and simple, self-explanatory operation. For each step in the input process the individual entry keys are assigned to appropriate functions and explained. The controller menu contains headwords for the measured values and settings, as well as help texts or clearly-structured graphics.

The SR14 can be used as a temperature difference controller for the various system variants illustrated and explained under B.5.

Important characteristics of the SR14:

- Depiction of graphics and texts in a lighted display
- Simple viewing of the current measurement values
- Analysis and monitoring of the system by means of statistical graphics, etc.
- Extensive setting menus with explanations
- Menu block can be activated to prevent unintentional changes of settings
- Resetting to factory settings

## B.4. - Versions

**This manual applies to the following different hardware versions:**

### SR14 Version 1

- 3 temperature sensor inputs
- 1 relay output 230AC (on/off)

### SR14 Version 2

- 3 temperature sensor inputs
- 1 electronic relay output 230AC (for speed control of standard pumps)

### SR14 Version 3

- 3 temperature sensor inputs
- 1 relay output 230AC (on/off)
- 1 PWM/0-10V output (for speed control of high efficiency pumps)

### SR14 Version 4

- 3 temperature sensor inputs
- 1 electronic relay output 230AC (for speed control of standard pumps)
- 1 PWM/0-10V output (for speed control of high efficiency pumps)

**Type:** Control Version 4



AC220...240V, 50/60Hz, 460VA



IP40



**When you are unsure which version you have, check the type label on the side of the controller.**

**If the version is not readable here, open the controller's "Service values" menu. The version is shown in the first line of the service values.**

# Description of controller

## B.5. - Scope of supply

- Temperature Difference Controller SR14
- 2 Screws 3,5x35mm, 2 plugs S6 for wall installation
- 4 strain relief clips with 8 screws, replacement fuse 2A slow blow
- 1 connection clamp for PE terminal block.
- Installation and operating instructions SR14

Optionally contained depending on design/order:

- 2-3 Pt1000 temperature sensors and immersion sleeves

Additionally available:

- Pt1000 temperature sensors, immersion sleeves, overvoltage protection

## B.6. - Disposal and pollutants

The unit conforms to the European RoHS directive 2002/95/EC for the restriction of the use of certain hazardous substances in electrical and electronic equipment.



Caution

The unit must not under any circumstances be disposed of with ordinary household refuse. Dispose of the unit only at appropriate collection points or ship it back to the seller or manufacturer.



# Description of controller

## B.7. - Hydraulic variants



The following illustrations should be viewed only as schematic diagrams showing the respective hydraulic systems, and do not claim to be complete. The controller does not replace safety devices under any circumstances. Depending on the specific application, additional system components and safety components may be mandatory, such as check valves, non-return valves, safety temperature limiters, scalding protectors, etc., and must therefore be provided.

① Solar with storage tank

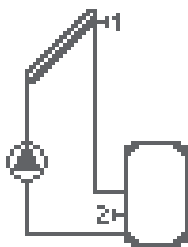

② Solar with Pool

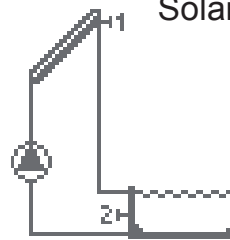

③ Solid fuel boiler with storage

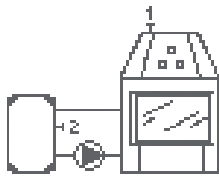

④ Storage transfer



⑤ Raising of heat circuit

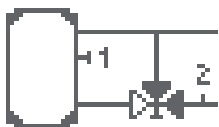

⑥ Thermostat

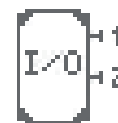

⑦  $\Delta T$  Universal



⑧ Stop valve

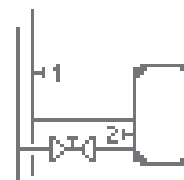

⑨ Solar with heat exchanger and pool

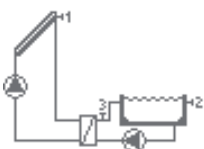

# Installation

## C.1 Wall installation



Install the controller only in dry areas and under the ambient conditions described under 2.1 "Specifications". Carry out the following steps:

### C.1.1

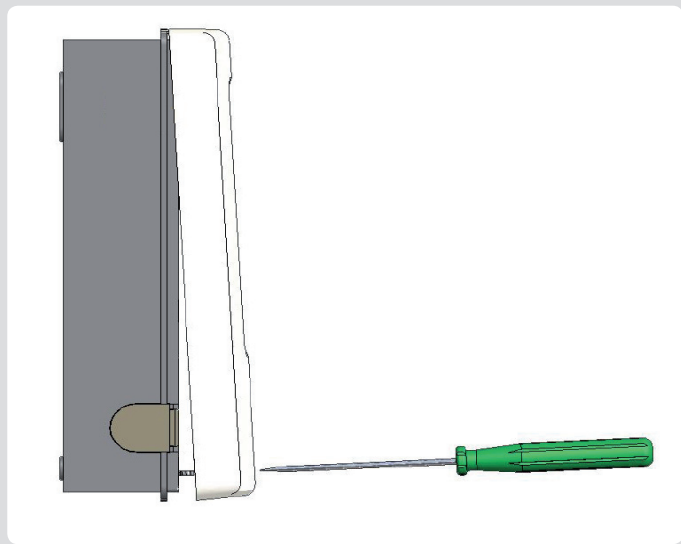

1. Unscrew cover screw completely

2. Carefully pull upper part of housing from lower part.

3. Set upper part of housing aside, being sure not to touch the electronics when doing so.

4. Hold the lower part of the housing (C.1.2) up to the selected position and mark the 2 mounting holes. Make sure that the wall surface is as even as possible so that the housing does not become distorted when it is screwed on.

### C.1.2

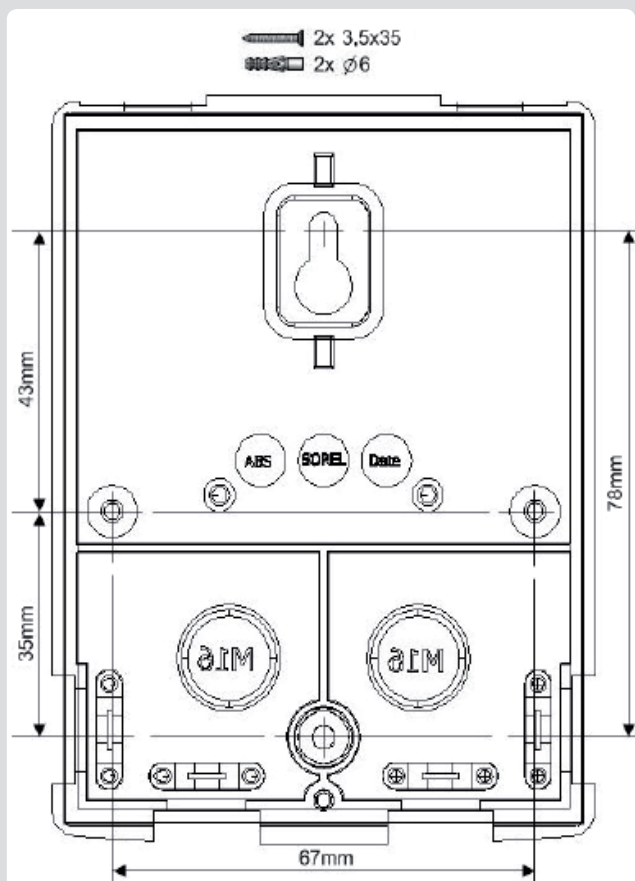

5. Using a drill and size 6 bit, drill 2 holes at the points marked on the wall and push in the plugs. Also possible is the installation with 4 drill holes.

6. Insert the upper screw and screw it in slightly.

7. Fit the upper part of the housing and insert the other screws.

8. Align the housing and tighten the screws.

# Installation

## C.2 Electrical connection



Before working on the unit, switch off the power supply and secure it against being switched on again! Check for the absence of power! Electrical connections may only be made by a specialist and in compliance with the applicable regulations. Do not use the controller if the housing shows visible damage.



Low-voltage cables such as temperature sensor cables must be routed separately from mains voltage cables. Feed temperature sensor cables only into the left-hand side of the unit, and mains voltage cables only into the right-hand side.



The customer must provide an all-pole disconnecting device, e.g. a heating emergency switch.



The cables being connected to the unit must not be stripped by more than 55mm, and the cable jacket must reach into the housing just to the other side of the strain relief.



We recommend the use of flexible cables to ease the installation in the clamp room.

### C.2.1

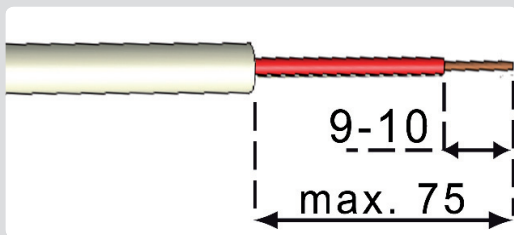

### C.2.1.a

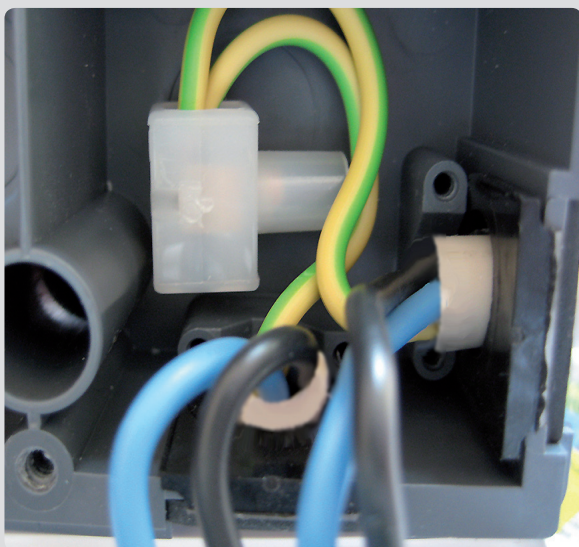

1. Select necessary program/hydraulics (see section D)
2. Strip cables by 55mm max., insert, fit the strain relief devices, strip the last 9-10 mm of the wires. (Fig. C.2.1)
3. Open controller as described under fig. C.1.1, insert cables and install strain reliefs
4. Install PE terminal block (see fig. 2.1.a).

continued on  
next page

# Installation

C.2.1.c

screw driver

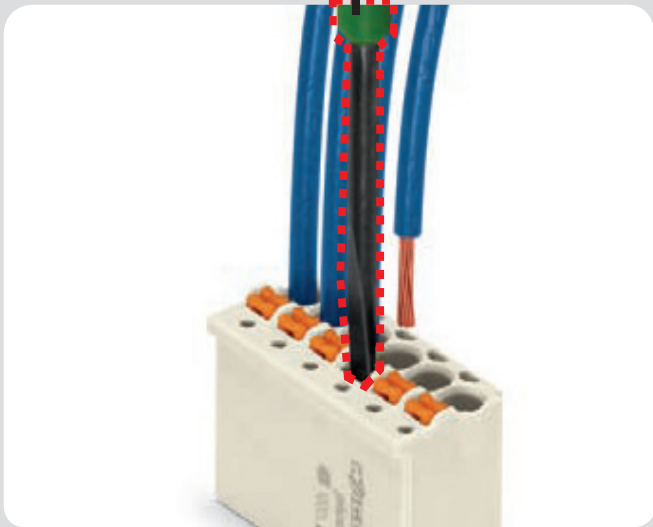

C.2.1.d



C.2.1.e

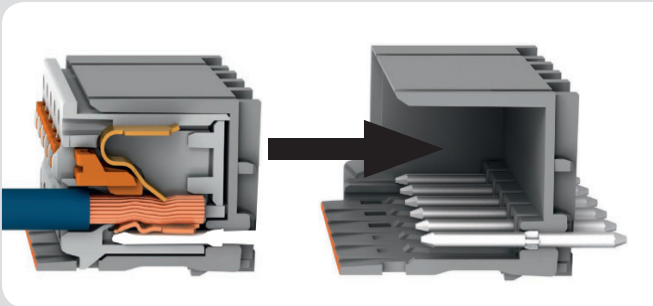

5. Connect the female connector block 's clamp connections as described in the terminal connection plans. When using stranded cables, use a small screw driver and push the orange buttons while inserting (see fig. C.2.1.c). When using solid cable or end splice, just push the cables in (see fig. C.2.1.d).
6. Plug Female connectors into onboard headers.
7. Hinge the upper part of the casing on the top of the lower part and close the casing gently.
8. Fasten with screw.
9. Switch on mains voltage and place controller in operation.

# Installation

## C.2.1.f



To remove the female connector block from the header, carefully bend the latch on the header.

Caution: The latch breaks easily.

## C.3 Installing the temperature sensors

The controller operates with Pt1000 temperature sensors which are accurate to the degree, thus ensuring optimal control of system functions.



Caution

Position the sensor precisely in the area to be measured!  
Only use immersion, pipe-mounted or flat-mounted sensors suitable for the specific area of application with the appropriate permissible temperature range.



Caution

The temperature sensor cables must be routed separately from mains voltage cables, and must not, for example, be routed in the same cable duct!



Caution

The line of S1 can be extended if needed to a maximum of 30m using a cable with a cross-section of at least 0.75mm<sup>2</sup>. The lines of S2 and S3 can be extended if needed to a maximum of 10m using a cable with a cross-section of at least 0.75mm<sup>2</sup>.

Make sure that there is no contact resistance!

# Installation

## D Terminal connection diagrams

### D.1 Solar with storage tank

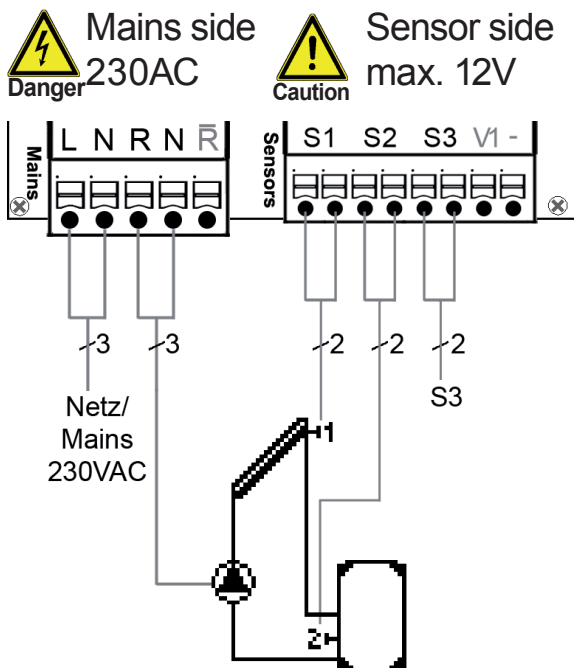

**Low voltage** max. 12VAC/DC connection

Terminal:      Connection for:

S1 (2x)      Sensor 1 collector

S2 (2x)      Sensor 2 Storage

S3 (2x)      Sensor 3 (optional)

The polarity of the sensors S1-S3 is freely selectable.

V1 / -      0-10V or PWM +/- (SR14 Version 3+4)

**Mains voltages 230VAC 50-60Hz**

Terminal:      Connection for:

L      Mains phase conductor L

N      Mains neutral conductor N

R      Pump phase conductor L

N̄      Pump neutral conductor N

R̄      Break contact (SR14 Version 1+3)

The **PE protective conductor** must be connected to the PE metal terminal block!

### D.2 Solar with swimming pool

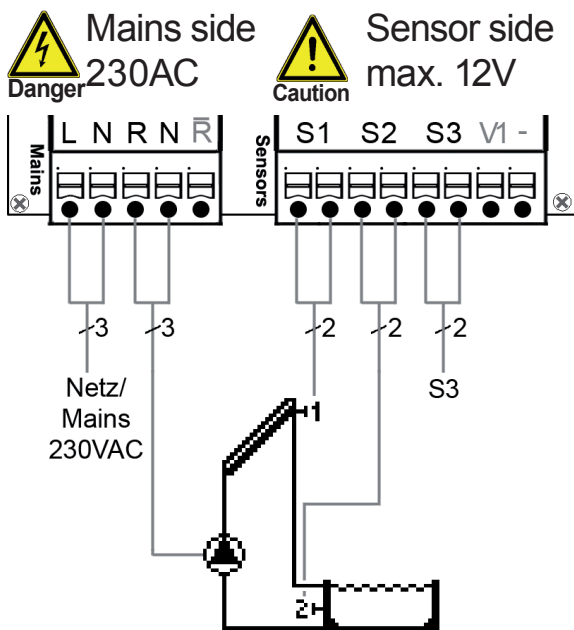

**Low voltage** max. 12VAC/DC connection

Terminal:      Connection for:

S1 (2x)      Sensor 1 collector

S2 (2x)      Sensor 2 pool

S3 (2x)      Sensor 3 (optional)

The polarity of the sensors S1-S3 is freely selectable.

V1 / -      0-10V or PWM +/- (SR14 Version 3+4)

**Mains voltages 230VAC 50-60Hz**

Terminal:      Connection for:

L      Mains phase conductor L

N      Mains neutral conductor N

R      Pump phase conductor L

N̄      Pump neutral conductor N

R̄      Break contact (SR14 Version 1+3)

The **PE protective conductor** must be connected to the PE metal terminal block!

# Installation

## D.3 Solid fuel with storage tank

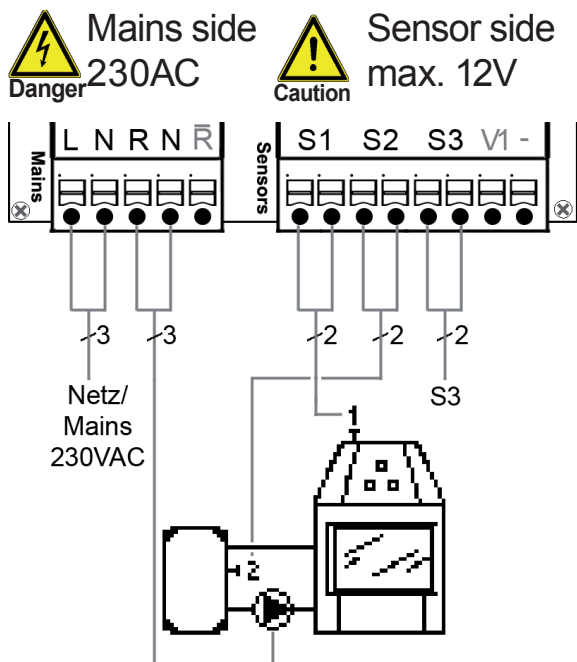

**Low voltage** max. 12VAC/DC connection

Terminal:	Connection for:
S1 (2x)	Sensor 1 Solid fuel boiler
S2 (2x)	Sensor 2 Storage
S3 (2x)	Sensor 3 (optional)
The polarity of the sensors S1-S3 is freely selectable.	
V1 / -	0-10V or PWM +/- (SR14 Version 3+4)

**Mains voltages 230VAC 50-60Hz**

Terminal:	Connection for:
L	Mains phase conductor L
N	Mains neutral conductor N
R	Pump phase conductor L
N	Pump neutral conductor N
R̄	Break contact (SR14 Version 1+3)
The <b>PE protective conductor</b> must be connected to the PE metal terminal block!	

## D.4 Storage transfer

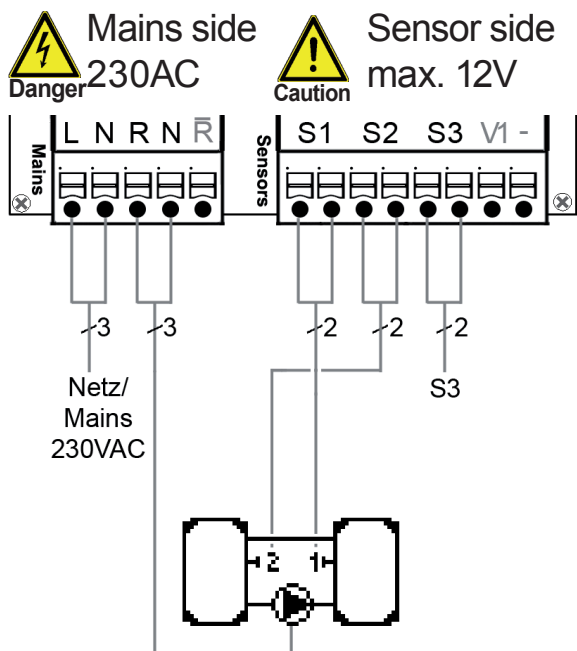

**Low voltage** max. 12VAC/DC connection

Terminal:	Connection for:
S1 (2x)	Sensor 1 storage
S2 (2x)	Sensor 2 storage
S3 (2x)	Sensor 3 (optional)
The polarity of the sensors S1-S3 is freely selectable.	
V1 / -	0-10V or PWM +/- (SR14 Version 3+4)

**Mains voltages 230VAC 50-60Hz**

Terminal:	Connection for:
L	Mains phase conductor L
N	Mains neutral conductor N
R	Pump phase conductor L
N	Pump neutral conductor N
R̄	Break contact (SR14 Version 1+3)
The <b>PE protective conductor</b> must be connected to the PE metal terminal block!	

The heat is transferred from storage 1 to storage 2

# Installation

## D.5 Raising of heat circuit

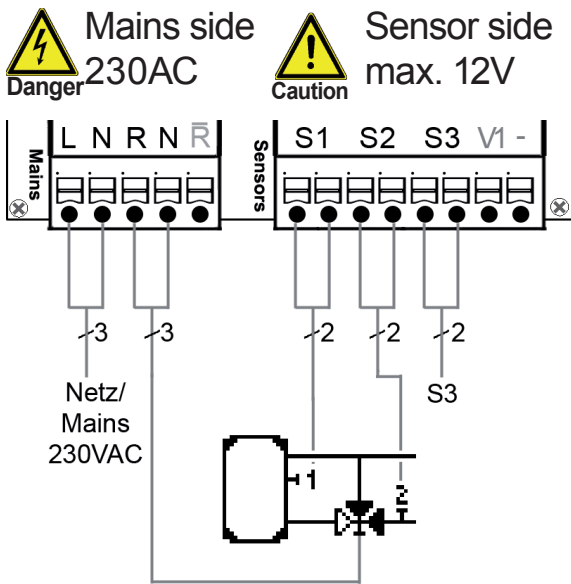

**Low voltage** max. 12VAC/DC connection

Terminal:      Connection for:

- S1 (2x)      Sensor 1 storage
- S2 (2x)      Sensor 2 backward flow
- S3 (2x)      Sensor 3 (optional)

The polarity of the sensors S1-S3 is freely selectable.  
V1 / -      0-10V or PWM +/- (SR14 Version 3+4)

**Mains voltages 230VAC 50-60Hz**

Terminal:      Connection for:

- L      Mains phase conductor L
- N      Mains neutral conductor N
- R      Valve phase conductor L
- N      Valve neutral conductor N
- R-bar      Break contact (SR14 Version 1+3)

The **PE protective conductor** must be connected to the PE metal terminal block!

**Caution** Actuating direction of valve:  
R1 on/valve on = direction through the storage tank

## D.6 Thermostat

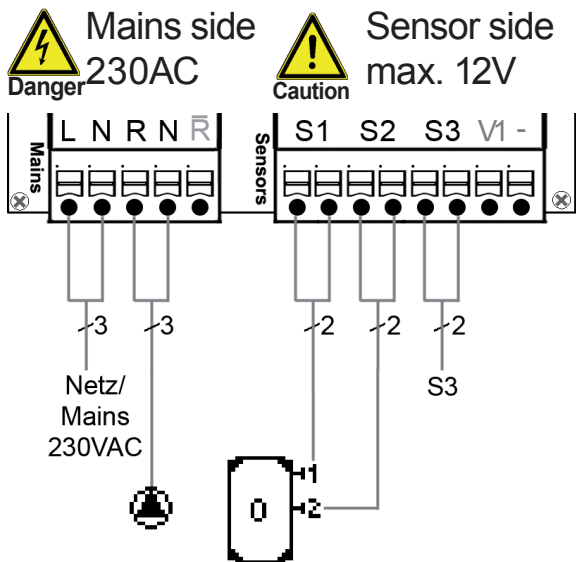

**Low voltage** max. 12VAC/DC connection

Terminal:      Connection for:

- S1 (2x)      Sensor 1 storage
- S2 (2x)      Sensor 2 (optional)
- S3 (2x)      Sensor 3 (optional)

The polarity of the sensors S1-S3 is freely selectable.  
V1 / -      0-10V or PWM +/- (SR14 Version 3+4)

**Mains voltages 230VAC 50-60Hz**

Terminal:      Connection for:

- L      Mains phase conductor L
- N      Mains neutral conductor N
- R      Pump phase conductor L
- N      Pump neutral conductor N
- R-bar      Break contact (SR14 Version 1+3)

The **PE protective conductor** must be connected to the PE metal terminal block!

When S2 is installed = S1 is switch-on sensor and S2 switch-off sensor.



# Installation

## D.7 Universal $\Delta T$ controller

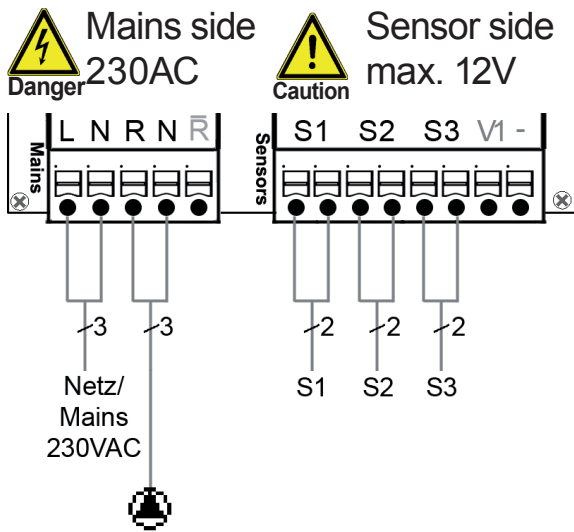

**Low voltage** max. 12VAC/DC connection

Terminal:	Connection for:
S1 (2x)	Sensor 1 control
S2 (2x)	Sensor 2 reference
S3 (2x)	Sensor 3 (optional)

The polarity of the sensors S1-S3 is freely selectable.  
V1 / - 0-10V or PWM +/- (SR14 Version 3+4)

**Mains voltages 230VAC 50-60Hz**

Terminal:	Connection for:
L	Mains phase conductor L
N	Mains neutral conductor N
R	Pump phase conductor L
N	Pump neutral conductor N
R̄	Break contact (SR14 Version 1+3)

The **PE protective conductor** must be connected to the PE metal terminal block!

Brief description of switching function: The  $\Delta T$  function sensor 1 > sensor 2 switches the pump at relay R.

## D.8 Stop valve

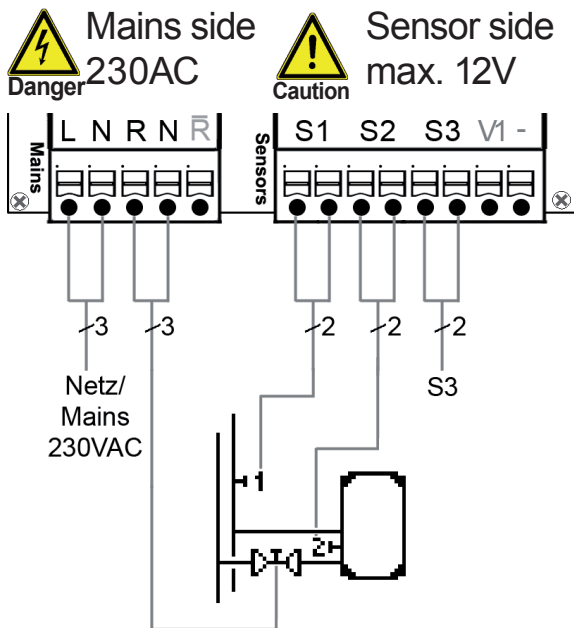

**Low voltage** max. 12VAC/DC connection

Terminal:	Connection for:
S1 (2x)	Sensor 1 flow
S2 (2x)	Sensor 2 storage
S3 (2x)	Sensor 3 (optional)

The polarity of the sensors S1-S3 is freely selectable.  
V1 / - 0-10V or PWM +/- (SR14 Version 3+4)

**Mains voltages 230VAC 50-60Hz**

Terminal:	Connection for:
L	Mains phase conductor L
N	Mains neutral conductor N
R	stop valve phase conductor L
N	stop valve neutral conductor N
R̄	Break contact (SR14 Version 1+3)

The **PE protective conductor** must be connected to the PE metal terminal block!

Brief description of switching function: The  $\Delta T$  function sensor 1 > sensor 2 switches relay R.

# Installation

## D.9 Solar with heat exchanger and pool

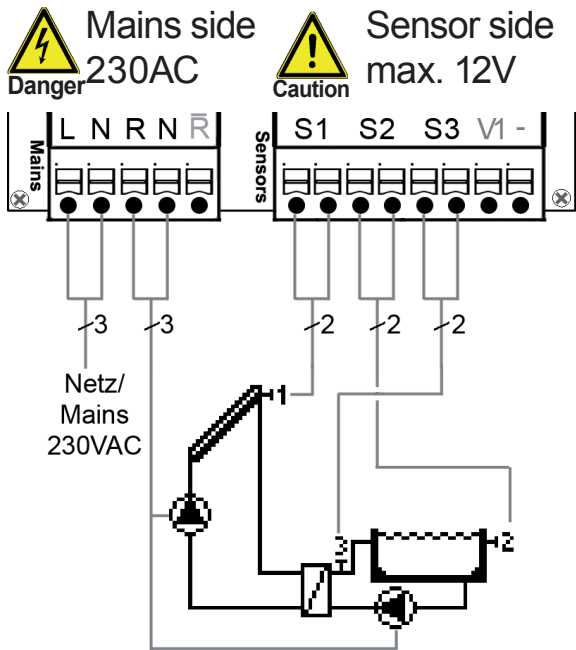

**Low voltage** max. 12VAC/DC connection

Terminal:      Connection for:

S1 (2x)      Sensor 1 collector

S2 (2x)      Sensor 2 pool

S3 (2x)      Sensor 3 secondary circuit

The polarity of the sensors S1-S3 is freely selectable.

V1 / -      0-10V or PWM +/- (SR14 Version 3+4)

**Mains voltages 230VAC 50-60Hz**

Terminal:      Connection for:

L      Mains phase conductor L

N      Mains neutral conductor N

R      Pump phase conductor L

N      Pump neutral conductor N

R      Break contact (SR14 Version 1+3)

The **PE protective conductor** must be connected to the PE metal terminal block!

# Operation

## E.1 Display and Input

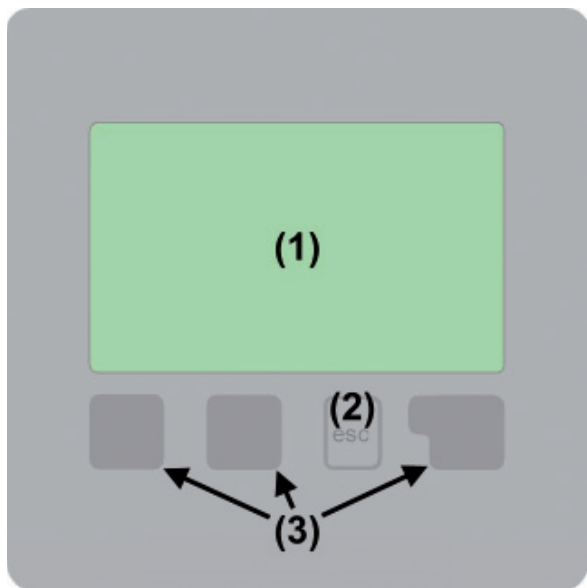











The display (1), with its extensive text and graphics mode, is almost self-explanatory, allowing easy operation of the controller.

Entries are made using four keys (2+3), which are assigned to different functions depending on the situation. The “esc” key (3) is used to cancel an entry or to exit a menu.

If applicable there will be a request for confirmation as to whether the changes which have been made should be saved.

Display symbols:

	Pump (rotates in operation)
	Valve (direction of flow black)
	Collector
	Storage tank
	Solid fuel boiler
	Swimming pool
	Temperature sensor
	Thermostat On / Off
	Warning / error message
	New information available

The function of each of the other three keys (3) is shown in the display line directly above the keys; the right-hand key generally has a confirmation and selection function.

Examples of key functions:

+/- = increase/reduce values

▼/▲ = scroll menu down/up

yes/no = approve/reject

Info = additional information

Back = to previous screen

ok = confirm selection

Confirm = confirm setting

# Operation

## E.2 Parametrisation



The first time the controller is turned on and after the language and time are set, a query appears as to whether you want to parametrise the controller using the commissioning help or not. The commissioning help can also be terminated or called up again at any time in the special functions menu. The commissioning help guides you through the necessary basic settings in the correct order, and provides

brief descriptions of each parameter in the display. Pressing the “esc” key takes you back to the previous value so you can look at the selected setting again or adjust it if desired. Pressing the “esc” more than once takes you back step by step to the selection mode, thus cancelling the commissioning help. Finally, under operating mode menu 4.2 “Manual” should be used to test the switch outputs with the consumers connected, and to check the sensor values for plausibility. Then switch on automatic mode.



Caution

Observe the explanations for the the individual parameters on the following pages, and check whether further settings are necessary for your application.

## E.3 Free commissioning

If you decide not to use the commissioning help, you should make the necessary settings in the following sequence:

- Menu 10. Language
- Menu 7.3 Time and date
- Menu 7.1 Program selection
- Menu 5. Settings, all values
- Menu 6. Protective functions if adaptations are necessary
- Menu 7. Special functions if additional changes are necessary

Finally, menu 4.2 under operating mode “Manual” should be used to test the switch outputs with the consumers connected, and to check the sensor values for plausibility. Then switch on automatic mode.



Caution

Observe the explanations for the the individual parameters on the following pages, and check whether further settings are necessary for your application.

# Operation

## E.4 Menu sequence and menu structure

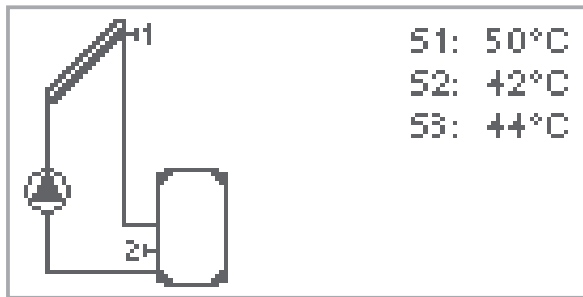

1. Measurements

2. Statistics

3. Display mode

4. Messwerte

5. Settings

6. Protections

7. Special functions

8. Menu lock

9. Service values

10. Language

The graphics or overview mode appears when no key has been pressed for 2 minutes, or when the main menu is exited by pressing "esc".

Pressing a key in graphics or overview mode takes you directly to the main menu. The following menu items are then available for selection there:

Current temperature values with explanations

Function control of the system with operating hours, etc.

Select graphics mode or overview mode

Automatic mode, manual mode or switch unit off

Set parameters needed for normal operation

Solar and frost protection, recooling, anti-seizing protection

Program selection, sensor calibration, clock, additional sensor, etc.

Against unintentional setting changes at critical points

For diagnosis in the event of an error

Select the menu language

# Measurement values

## 1. - Measurement values



The menu “1. Measurement values” serves to display the currently measured temperatures.

The menu is closed by pressing “esc” or selecting “Exit measurements”.

Selecting “Details” leads to a brief help text explaining the measurement values.

Selecting “Overview” or “esc” exits the Info mode.

If “Error” appears on the display instead of the measurement value, then there may be a defective or incorrect temperature sensor.



Caution

If the cables are too long or the sensors are not placed optimally, the result may be small deviations in the measurement values. In this case the display values can be compensated for by making entries on the controller. Follow the instructions under 7.3.

What measurement values are displayed depends on the selected program, the connected sensors and the specific device design.

# Statistics

## 2. - Statistics

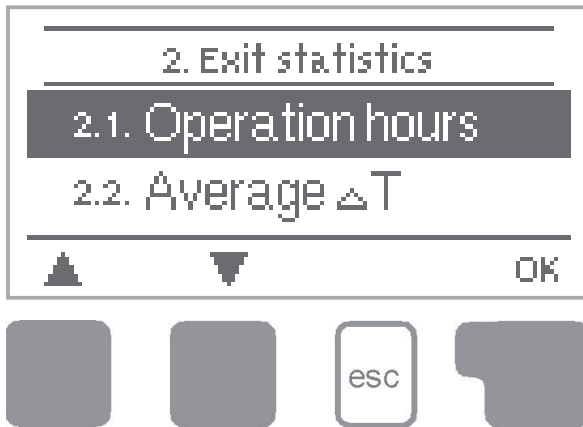

The menu “2. Statistics” is used for function control and long-term monitoring of the system.

The menu is closed by pressing “esc” or selecting “Exit statistics”.



Caution

For analysis of the system data it is essential for the time to be set accurately on the controller. Please note that the clock continues for about 24 hours if the mains voltage is interrupted, and must be reset afterwards. Improper operation or an incorrect time may result in data being deleted, recorded incorrectly or overwritten. The manufacturer accepts no liability for the recorded data!

### 2.1. - Operating hours

Display of operating hours of the solar pump connected to the controller; various time ranges (day-year) are available.

### 2.2. - Average temperature difference $\Delta T$

Display of the average temperature difference between the reference sensors of the solar system with the consumer switched on.

### 2.3. - Heat output

Display of the heat output of the system. This menu can only be selected, however, when the function „7.8. - Heat quantity“ is activated.

### 2.4. - Graphic overview

This provides a clearly-organised display of the data listed under 2.1 - 2.3 as a bar graph. Various time ranges are available for comparison. The two left-hand keys can be used to page through the data.

### 2.5. - Message log

Display of the last 20 errors occurring in the system with indication of date and time.

### 2.6. - Reset / clear

Resetting and deleting the individual analyses. The function “All statistics” clears all analyses but not the error messages.

# Display mode

## 3. - Display mode



Menu “3. Display mode” is used to define the controller’s display for normal operation. This display appears whenever two minutes go by without any key being pressed. The main menu appears again when a key is pressed. The menu is closed by pressing “esc” or selecting “Exit display mode”.

### 3.1. - Schematic

In graphics mode, the selected hydraulic systems are depicted graphically with the measured temperatures and operating states of the connected consumers.

### 3.2. - Overview

In overview mode, the measured temperatures and operating states of the connected consumers are depicted in text form.

### 3.3. - Alternating

In alternating mode the schematic mode and then the overview mode are active for 5 seconds at a time.

### 3.4. - Eco Mode

Eco mode switches the backlight of the display off after 2 minutes of inactivity.

*Default: Off*



If a message (e.g. error) is shown, the backlight stays on until the message was read.



# Operating modes

## 4. - Operating modes



In menu “4. Operating modes” the controller can either be placed in automatic mode, switched off, or placed in a manual operating mode.

The menu is closed by pressing “esc” or selecting “Exit operating modes”.

### 4.1. - Automatic

Automatic mode is the normal operating mode of the controller. Only automatic mode provides proper controller function taking into account the current temperatures and the parameters that have been set! After an interruption of the mains voltage the controller automatically returns to the last operating mode selected!

### 4.2. - Manual

The relay and thus the connected consumer are switched on and off by pressing a key, with no regard to the current temperatures and the parameters which have been set. The measured temperatures are also shown to provide an overview and function control.



When operating mode “Manual” is activated, the current temperatures and the selected parameters are no longer considered. There is a danger of scalding or serious damage to the system. The operating mode “Manual” may only be used by specialists for brief function tests or during commissioning!

### 4.3. - Off



When the operating mode “Off” is activated, all controller functions are switched off. This can lead, for example, to overheating on the solar collector or other system components. The measured temperatures continue to be shown to provide an overview.

# Settings

## 5. - Settings

5. Exit adjustments	
5.1. Tmin S1	20°C
5.2. Tmax S2	60°C
 	Details



The necessary basic settings required for the control function are made in menu “5. Settings”.



Caution

This does not under any circumstances replace the safety facilities to be provided by the customer!

The menu is closed by pressing “esc” or selecting “Exit settings”.



Caution

Various settings can be made depending on the selection of hydraulic variant. The following pages contain generally valid descriptions for the settings.

### 5.1 - Tmin S1

#### Enable/start temperature at sensor 1

If this value is exceeded at sensor 1 and the other conditions are also met, then the controller switches the pump and/or valve on. If the temperature at sensor 1 drops below this value by 5K, then the pump and/or valve is switched off again.

*Setting range: from 0°C to 99°C / default setting: 20°C (solid fuel boiler: 60°C)*



Caution

When using application 3 with solid fuel boiler, at least 60°C should be set. Consider instructions of boiler manufacturer!

### 5.4 - Tmax S2

#### Switch-off temperature at sensor 2

If this value is exceeded at sensor 2 and the other conditions are also met, then the controller switches the pump and/or valve off. If sensor 2 falls below this value again and the other conditions are also met, then the controller switches the pump and/or valve on again.

*Setting range: from Off (Solid fuel boiler), 0°C to 99°C (can be switched off in thermostat systems)*

*Default setting: 60°C (swimming pool: Default: 30°C)*



Danger

Temperature values which are set too high can lead to scalding or damage to the system. Scalding protection must be provided by the customer!

# Settings

## 5.8 - $\Delta T$ R1

### Switching condition: Temperature difference for relay R1:

If the temperature difference  $\Delta T$  between the reference sensors is exceeded and the other conditions are also met, then the controller switches the pump/valve on. If the temperature difference between the reference sensors drops to  $\Delta T_{off}$ , then the pump/valve is switched off again.

*Settings range:  $\Delta T$ : 3°C to 50°C /  $\Delta T_{off}$ : 2°C to  $\Delta T$  minus 1*

*Default:  $\Delta T$  10°C /  $\Delta T_{off}$  3°C.*



Caution

If the set temperature difference is too small, this may result in ineffective operation or frequent clocking (switch-on and switch-off) of the pump.

## 5.11 - Tref (Thermostat)

### Reference temperature at sensor 1

Heating = 1st value smaller than the 2nd value

If the temperature drops below Tref On (1. value) at sensor 1 and the thermostat function is enabled, (see 5.5), the relay for additional heating is switched on until the temperature reaches Tref Off (2. value).

Cooling = 1st value higher than the 2nd value

If the temperature exceeds Tref On (1. value) at sensor 1 and the thermostat function is enabled (see 5.5), the relay for cooling is switched on until the temperature drops below Tref Off (2. value).

*Settings range:*

*Tref On: -10°C - 90°C / Default: 50°C*

*Tref Off: -20°C - 99°C / Default: 60°C*



Caution

When sensor S2 is installed, S1 is used as lead for switch on and S2 as switch off.

## 5.20 - Tmax S1

### Switch-off temperature at sensor 1

If this value is exceeded at sensor 1 and the other conditions are also met, then the controller switches the pump and/or valve off. If sensor 1 falls below this value again and the other conditions are also met, then the controller switches the pump and/or valve on again.

*Setting range: from 0°C to 99°C*

*Default setting: 60°C*



Danger

Temperature values which are set too high can lead to scalding or damage to the system. Scalding protection must be provided by the customer!

# Settings

## 5.21 - Thermostat times

Set the desired periods of time when the thermostat should be active. 2 periods can be set per day, settings can also be copied to other days. Outside the set times the thermostat is switched off.

*Setting range: from 00:00 to 23:59 /default setting: 06:00 to 22:00*

## 5.22 - Tmax S3

### Switch-off temperature at sensor 3

If this value is exceeded at sensor 3 and the other conditions are also met, then the controller switches the relay off. If sensor 3 falls below this value again and the other conditions are also met, then the controller switches the relay on again.

*Setting range: from 0°C to 99°C*

*Default setting: 60°C (in systems not using S3: Default Off)*



Temperature values which are set too high can lead to scalding or damage to the system. Scalding protection must be provided by the customer!

## Party Funktion (Thermostat only)



With the party function the storage temperature is heated up once to the reference temperature (Tref off), disregarding the set thermostat times.

The party mode is enabled by pressing the „esc“-key for 3 seconds in the main menu. While this mode is active, the system heats up to the reference “Tref Off”, regardless of preset thermostat times. The mode is ended once the required temperature is reached.

# Protective functions

## 6. - Protective functions



Menu “6. Protective functions” can be used to activate and set various protective functions.



Caution

This does not under any circumstances replace the safety facilities to be provided by the customer!

The menu is closed by pressing “esc” or selecting “Exit settings”.

### 6.1. - Seizing protection

If the Seizing protection is activated, then the controller switches the associated pump and/or valve on every day at 12:00 or on Sundays at 12:00 for 5 seconds in order to prevent the pump and/or valve from sticking after an extended stationary period.

*Setting range: daily, weekly, off / default value: Off*

### 6.2. - Frost protection (solar only)

A two-stage frost protection function can be activated. In stage 1 the controller switches the pump on for 1 minute every hour if the collector temperature drops below the set value “Frost stage 1”.

If the collector temperature drops further to the set value “Frost stage 2” the controller switches the pump on continuously. If the collector temperature then exceeds the value “Frost stage 2” by 2°C, the pump switches off again.

*Frost protection setting range: on, off / default setting: off*

*Frost stage 1 setting range: from -25°C to 10°C or off / default setting: 7°C*

*Frost stage 2 setting range: from -25°C to 8°C / default setting: 5°C*



Caution

This function causes energy to be lost via the collector! It is normally not activated for solar systems with antifreeze. Observe the operating instructions for the other system components!

# Protective functions

## 6.3. - System protection (solar only) priority protection

System protection prevents overheating of system components by automatic shutdown of the solar pump. If “AS Ton” is exceeded at the collector, the pump is switched off. The pump is activated again when the temperature drops below “AS TOff”.

*Automatic shutdown - settings range: On / Off / Default: on*

*AS Ton - settings range: 60 °C to 150 °C / Default: 120 °C*

*AS Toff - settings range: 50 °C to Ton minus 5 °C / Default: 110 °C*



Caution

When system protection is on, the temperature in the idle collector will be very high, thus the pressure in the system will rise and can damage your system. Pay close attention to the instructions of the system manufacturer.

## 6.4. - Collector protection (solar only)

Collector protection prevents overheating of the collector. The pump is switched on to transfer heat from the collector to the storage tank.

If “CP Ton” is exceeded at the collector sensor, the pump is switched on until the temperature reaches “CP Toff” or the temperature “CP Tmax storage” is exceeded in the storage or pool.

*Collector protection settings range: on / off / Default: off*

*CP Ton settings range: 60°C to 150°C / Default: 110°C*

*CP Toff settings range: 50°C to Ton minus 10°C / Default: 100°C*

*CP Tmax storage settings range: 0°C to 140°C / Default: 90°C*



Danger

When collector protection is active, the storage or pool is heated well beyond Tmax S2 (see 5.2) which can result in scalding and system damage.

## 6.5. - Col.- Alarm (solar only)

If this temperature is exceeded at the collector sensor when the solar pump is on a warning or error message is triggered. A warning message is shown in the display.

*Collector alarm settings range: on / off / Default: off*

*Col. alarm - setting range: 60 °C to 300 °C / Default: 150 °C*

# Protective functions

## 6.6. - Recooling (solar only)

In hydraulic systems with solar when the recooling function is activated excess energy from the storage tank is fed back into the collector. This only takes place if the temperature in the storage tank is higher than the value "Recool Tsetpoint" and the collector is at least 20°C cooler than the storage tank and until the storage tank temperature has dropped below the value "Recool Tsetpoint".

*Recooling settings range: on / off / Default: off*

*Recooling Tset settings range: 0°C to 99°C / Default: 70°C*



Caution

This function causes energy to be lost via the collector! The recooling should only be activated in exceptional cases.

# Protective functions

## 6.7. - Anti-Legionella

With the “AL function” activated the SR14 makes it possible to heat the storage tank up to a higher temperature (“AL Tsetpoint S2”, provided that the energy source allows this. Time periods where the AL heat up is attempted are to be setup in the menu “AL times” Once the temperature “AL Tset S2” is reached, the controller will try to maintain this temperature for the time period set in “AL residence time”. When this happened, the time and date is saved and displayed in the menulog “AL heat”.

*AL Function settings range: on / off / Default: off*

*AL Tset S2 (Thermostat uses both S1 and S2) settings range: 60°C to 99°C /  
Default: 70°C*

*AL residence time - settings range: 1 to 60 minutes / Default: 15 minutes*

*AL heat. (no setting): Displays the date and time of the last successful AL heat up*

*AL times - settings range: Mo-Su , 0-24h/ Default: daily 3-5h*



Caution

The anti-Legionella function is switched off at delivery.

**For solar:** This function is only relevant for storage tanks where sensor 2 is installed. Whenever heating-up has been carried out with the anti-Legionella function being switched on, an information message with the date is shown in the display.

**For thermostat:** S1 is used as switch-off sensor. When both S1 and S2 are connected, they both have to reach AL Tset S1 to successfully finish the AL heat up.



Danger

During the anti-Legionella function the storage tank is heated up over the set value “Tmax S2”, which can lead to scalding and damage to the system.



Caution

This anti-Legionella function does not provide complete protection against Legionella, because the controller is dependent on sufficient energy being fed in, and it is not possible to monitor the temperatures in the entire range of the storage tanks and the connected piping system. To provide complete protection against Legionella bacteria, it must be ensured that the temperature is raised to the necessary temperature, and at the same time there must be water circulation in the storage tank and piping system by means of other additional energy sources and control units.



# Special functions

## 7. - Special functions



Menu “7. Special functions” is used to set basic items and expanded functions.



Other than the time all settings may only be made by a specialist.

The menu is closed by pressing “esc” or selecting “Exit special functions”.



Caution

Menu enumerations may vary according to SR14 version used.

### 7.1. - Program selections

The suitable hydraulic variant for the specific application is selected and set here (see section D: Hydraulic variants). The associated diagram can be displayed by pressing “info”.

*Setting range: 1-9 / default value: 1*



Caution

Normally the program selection is made only once during initial commissioning by the specialist. Incorrect program selection can lead to unpredictable errors.

### 7.2. - Signal V1 (only SR14 Version 3 + 4)

This menu contains the settings for 0-10V or PWM pump.



Caution

When selecting this submenu, you may be prompted to save the speed control settings.

# Special functions

## 7.2.1. - Type of signal

The type of speed controlled pump is entered here.

Depending on the SR14 Version used various selections are possible:

(only SR14 version 2 + 4)

**Standard:** Speed control for standard pumps 230AC on output R1.

Use only for standard pumps! PWM / 0-10V output switched off.

(only SR14 version 3 + 4)

**0-10V:** Speed control for special pumps via output V1 (e.g. High efficiency pumps) by means of a 0-10V. Relay output R1 (230AC) is switched on for power supply when output V1 is switched on.

**PWM:** Speed control for special pumps via output V1 (e.g. High efficiency pumps) by means of a PWM signal. Relay output R1 (230AC) is switched on for power supply when output V1 is switched on.

## 7.2.2. - Profile

In this menu, preconfigured profiles for various pumps can be selected. Alternatively, all settings can be done manually. Please note that individual settings are still possible even when a profile has been selected.

## 7.2.3. - Output Signal

This menu determines the type of pump used: Solar pumps perform at their highest power when the signal is also maxed, heating pump on the other hand are set to highest power when the control signal is at the lowest. Solar = normal, heating = Inverted.  
*Settings range: Normal, Inverted / Default setting: Normal*

# Special functions

When Output signal PWM is selected:

## 7.2.4. - PWM off

This signal is put out when the pump is switched off (Pumps that can detect cable break need a minimum signal).

*Settings range: (Solar:) 0 to 50% / Default setting: 0% - (Heating:) 50% to 100% / Default setting: 100%*

## 7.2.5. - PWM on

This signal is needed to turn the pump on at minimum speed.

*Settings range: (Solar:) 0 to 50% / Default setting: 10% - (Heating:) 50% to 100% / Default setting: 90%*

## 7.2.6. - PWM Max

This determines the output signal for the highest speed of the pump, that is used e.g. during purging or manual operation.

*Settings range: (Solar:) 50 to 100% / Default setting: 100% - (Heating:) 0% to 50% / Default setting: 0%*

When Output signal 0-10V is selected:

## 7.2.4 - 0-10V off

This voltage is put out when the pump is turned off (Pumps that can detect cable break need a minimum voltage).

*Settings range: (Solar:) 0,0 to 5,0 V / Default setting: 1,0 V - (Heating:) 5,0 to 0,0 V / Default setting: 4,0 V*

## 7.2.5 - 0-10V on

This voltage is needed to turn the pump on at minimum speed.

*Settings range: (Solar:) 0,0 to 5,0 V / Default setting: 1,0 V - (Heating:) 5,0 to 10,0 V / Default setting: 9,0 V*

## 7.2.6 - 0-10V Max

This determines the output voltage for the highest speed of the pump, that is used e.g. during purging or manual operation

*Settings range: (Solar:) 5,0 to 10,0 V / Default setting: 10,0 V - (Heating:) 0,0 to 5,0 V / Default setting: 0,0 V*

# Special functions

## 7.2.7. - Speed when „On“

This menu determines the calculated and displayed speed of the pump. If e.g. 30% is set here and the signal set in „PWM on/0-10V on“ is put out, 30% speed is displayed. When the signal set in „PWM max/0-10V max“ is put out, 100% speed is displayed. Everything in between is calculated accordingly.

*Settings range: 10 to 90 % / Default setting: 30 %*



Caution

This function has no influence on the regulation, but changes only the speed displayed.

## 7.2.8. - Show signal

Displays the set signal in text and a graphical diagram.

### 7.2.8.a Example for pump settings

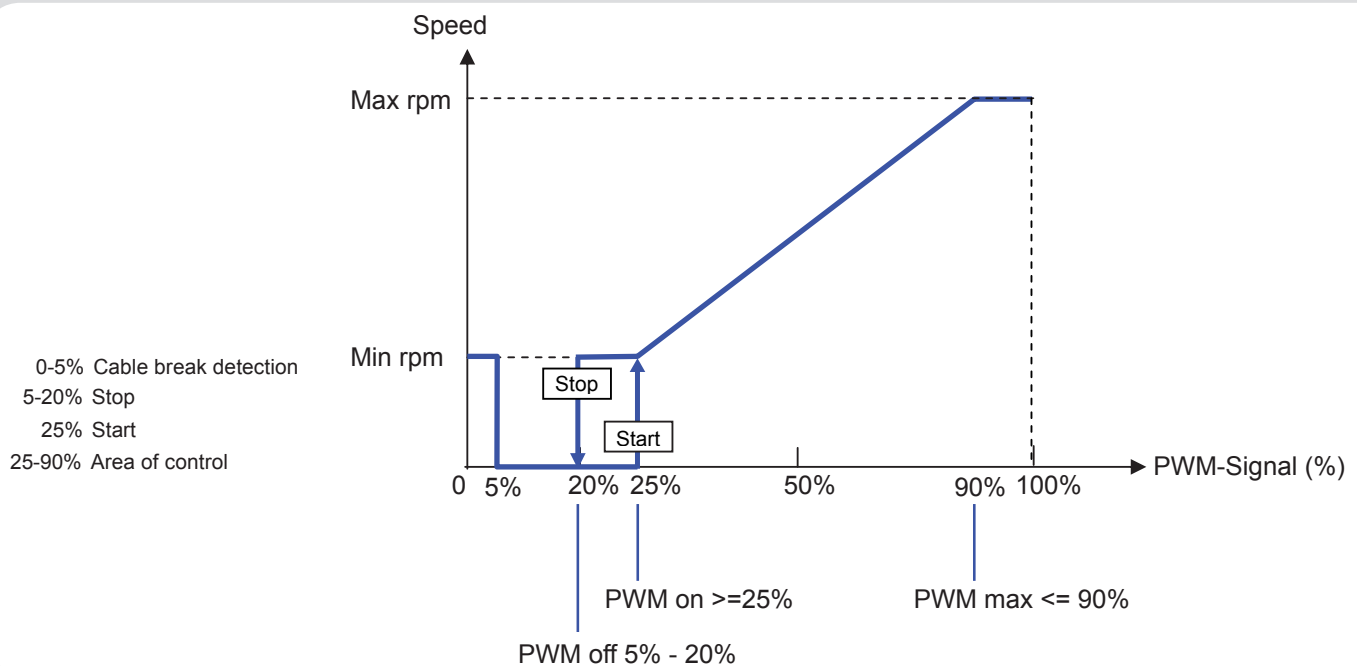

# Special functions

## 7.2.8.b Technical data PWM and 0-10V

### Technical data PWM:

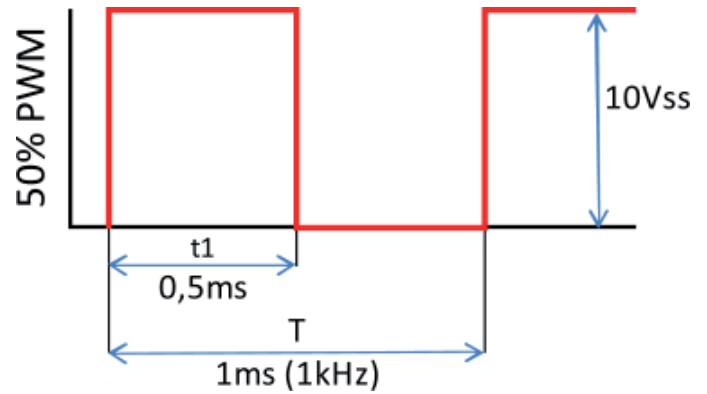
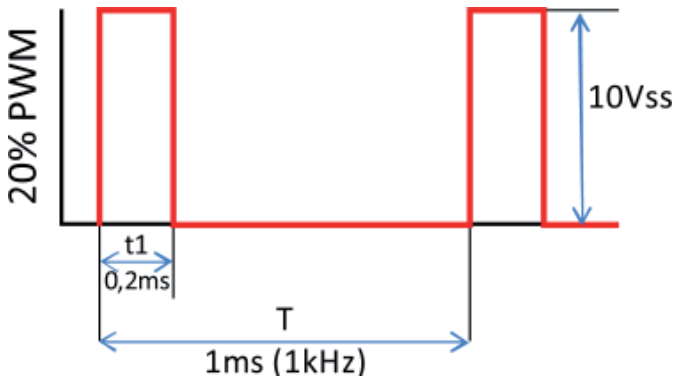

PWM: 20% to 100%, 1kHz  
Designed for a load of  
10K Ohm

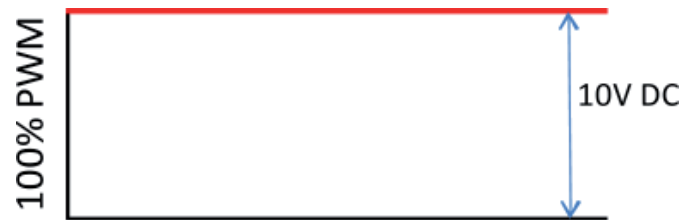

### Technical data 0-10V:

0-10V: 2V to 10V (20% to 100%)  
Designed for a load of 10K Ohm.

10V = 100% Speed

5V = 50% Speed

2V = 20% Speed

0V = Off

# Special functions

## 7.3. - Speed control

(only SR14 version 2, 3 and 4)

If the speed control is activated, the SR14 makes it possible to vary the speed of standard pumps at relay by means of special internal electronics.



This function should only be activated by a specialist. Depending on the pump and pump stage used, the minimum speed should not be set too low, because otherwise the pump or the system may be damaged. The information provided by the relevant manufacturer must also be observed! If in doubt, the min. speed and the pump stage should generally be set too high rather than too low.

### 7.3.1. - Speed control mode

(only SR14 version 2, 3 and 4)

The following speed variants are available here:

**Off:** There is no speed control. The connected pump is only switched on or off with full speed.

**Mode V1:** After the purging time the controller switches to the set max. speed. If the temperature difference  $\Delta T$  between the reference sensors (collector and storage tank) is smaller than the set value  $\Delta T R1$ , then the speed is decreased.

If the temperature difference between the reference sensors is greater than the set value (Switch-on temperature difference  $\Delta T R1$ ), then the speed is increased. If the controller has adjusted the speed of the pump down to the smallest stage and the  $\Delta T$  between the reference sensors is  $\Delta T off$ , the pump is switched off.

**Mode V2:** After the purging time the controller switches to the set min. speed. If the temperature difference  $\Delta T$  between the reference sensors (collector and storage tank) is greater than the set value, then the speed is increased. If the temperature difference  $\Delta T$  between the reference sensors is below the set value, then the speed is decreased. If the controller has adjusted the speed of the pump down to the smallest stage and the  $\Delta T$  between the reference sensors is  $T\Delta off$ , the pump is switched off.

**Mode V3:** After the purging time the controller switches to the set min. speed. If the temperature at the reference sensor (collector, in systems with heat exchanger on relay 2 the heat exchanger instead) is greater than the setpoint to be set subsequently, then the speed is increased. If the temperature at the reference sensor (collector) is less than the setpoint to be set subsequently, then the speed is decreased.

*Setting range: V1,V2,V3, off/default setting: off*

# Special functions

## 7.3.2. - Purging time

During this time period, the pump is running with full speed (100%) to ensure trouble-free startup. After this time has passed, the pump is set to speed control and is set to max. speed or min speed, depending on the speed control variant. Purging time can not be applied with PWM or 0-10V output.

*Settings range: 5 to 600 seconds / Default setting: 8 seconds*

## 7.3.3. - Sweep time

Sweep time determines the inertia of the speed control to prevent strong fluctuations in temperature. Sweep time is the time span for a complete change from minimum to maximum pump speed.

*Settings range: 1 to 15 minutes / Default setting: 4 minutes*

## 7.3.4. - max. speed

The maximum speed of the pump is specified here. During the setting the pump runs at the specified speed and the flow rate can be determined.

*Settings range: 70% to 100% / Default setting: 100%*



Caution

The indicated percentages are guide values that may vary to a greater or lesser extent depending on the system, pump and pump stage. 100% is the maximum voltage/frequency of the controller.

## 7.3.5. - min. speed

The minimum speed of the pump at relay R1 is specified here. During the setting the pump runs at the specified speed and the flow rate can be determined.

*Settings range: 30% to max. speed -5% / Default setting: 50%*



Caution

The indicated percentages are guide values that may vary to a greater or lesser extent depending on the system, pump and pump stage. 100% is the maximum voltage/frequency of the controller.

## 7.3.6. - Setpoint

This value is the control setpoint for mode 3 „7.3.1. - Speed control mode“ on page 38 . If the value at the sensor drops below this, the speed is reduced. If it rises above this, the speed is increased.

*Settings range: 0° to 90°C / Default setting: 60°C*

# Special functions

## 7.4. - Time and Date

This menu is used to set the current time and date.



Caution

For analysis of the system data it is essential for the time to be set accurately on the controller. Please note that the clock has a 24 hour battery and must be reset if the power was cut for a longer period.

## 7.5. - Sensor calibration

Deviations in the temperature values displayed, for example due to cables which are too long or sensors which are not positioned optimally, can be compensated for manually here. The settings can be made for each individual sensor in steps of 0.5°C. *Offset S1...S3 per setting range: -10°C...+10°C / Default: 0°C*



Caution

Settings are only necessary in special cases at the time of initial commissioning by the specialist. Incorrect measurement values can lead to unpredictable errors.

## 7.6. - Commissioning

Starting the commissioning help guides you in the correct order through the basic settings necessary for commissioning, and provides brief descriptions of each parameter in the display. Pressing the “esc” key takes you back to the previous value so you can look at the selected setting again or adjust it if desired. Pressing the “esc” more than once takes you back to the selection mode, thus cancelling the commissioning help.



Caution

May only be started by a specialist during commissioning! Observe the explanations for the the individual parameters in these instructions, and check whether further settings are necessary for your application.

## 7.7. - Factory settings

All of the settings that have been made can be reset, thus returning the controller to its delivery state.



Caution

The entire parametrisation, analyses, etc. of the controller will be lost irrevocably. The controller must then be commissioned once again.



# Special functions

## 7.8. - Heat quantity

A simple heat metering function for basic system control can be activated in this menu. Additional settings regarding the glycol, the percentage of type of glycol and the flow rate of the system are required. A correction value for the heat metering is also possible by adjusting the "Offset  $\Delta T$ "



Caution

Keep in mind that the system is not changed, adjustments made in this menu are only used to calculate the heat volume and should be based on the actual system. Resulting data is only approximate value for function control!

### 7.8.1. - Heat metering

Activate or deactivate the heat metering function

*Settings range: On/off /default setting: Off*

### 7.8.2. - AF type

Adjust the type of glycol that is being used in the system.

*Settings range: Ethylene/Propylene /default setting: Ethylene*

### 7.8.3. - Glycol portion

Adjust the percentage of glycol that is being used in the system.

*Settings range: 0-60% /default setting: 45%*

### 7.8.4. - Flow rate

Adjust the flow rate according to the system.

*Settings range: 0-100 l/min /default setting: 5 l/min*

### 7.8.5. - $\Delta T$ Offset

Since the calculation of the heat metering is based on the temperature of the collector and storage where measuring takes place, a possible deviation from the flow and return temperature can be compensated with this value.

Example: Displayed collector temp. 40° C, measured flow temp. 39° C, displayed storage temp. 30° C, measured return temp. 31° C means a setting of -20% (Displayed  $\Delta T$  10K, actual  $\Delta T$  8K => -20% correction value)

*Settings range: -50% to +50% /default settings: 0%*



Caution

Resulting data is only approximate value for function control!

# Special functions

## 7.9. - Starting aid

### (solar only)

With some solar systems, especially with vacuum tube collectors, it may occur that the measurement value acquisition at the collector sensor occurs too slowly or too inaccurately because the sensor is often not at the hottest location. When the start help is activated the following sequence is carried out:

If the temperature at the collector sensor increases by the value specified under “Increase” within one minute, then the solar pump is switched on for the set “Purging time” so that the medium to be measured can be moved to the collector sensor. If this still does not result in a normal switch-on condition, then the start help function is subject to a 5-minute lockout time.

*Start help setting range: on, off/default setting: off*

*Purging time setting range: 2 ... 30 sec./default setting: 5 sec.*

*Increase setting range: 1°C....10°C/default setting: 3°C/min.*



Caution

This function should only be activated by a specialist if problems arise with acquisition of measurement values. In particular follow the instructions from the collector manufacturer.

## 7.10. - Daylight saving time

When this function is active, the controller’s clock changes automatically to and from DST (DST, Daylight Savings Time).

# Menu lock

## 8. - Menu lock



Menu "8. Menu lock" can be used to secure the controller against unintentional changing of the set values.

The menu is closed by pressing "esc" or selecting "Exit menu lock".

The menus listed below remain completely accessible despite the menu lock being activated, and can be used to make adjustments if necessary:

1. Measurement values
2. Analysis
3. Display mode
- 7.2. Time&date
8. Menu lock
9. Service values

To lock the other menus, select "Menu lock on".

To enable the menus again, select "Menu lock off".

*Setting range: on, off/default setting: off*

# Service values

## 9. - Service values

9.2. Collector	50°C
9.3. Storage 1	42°C
9.4. Storage 2	44°C

The menu “9. Service values” can be used for remote diagnosis by a specialist or the manufacturer in the event of an error, etc.



Caution

Enter the values at the time when the error occurs e.g. in the table.

The menu can be closed at any time by pressing “esc”.



9.1.		9.21.		9.41.	
9.2.		9.22.		9.42.	
9.3.		9.23.		9.43.	
9.4.		9.24.		9.44.	
9.5.		9.25.		9.45.	
9.6.		9.26.		9.46.	
9.7.		9.27.		9.47.	
9.8.		9.28.		9.48.	
9.9.		9.29.		9.49.	
9.10.		9.30.		9.50.	
9.11.		9.31.		9.51.	
9.12.		9.32.		9.52.	
9.13.		9.33.		9.53.	
9.14.		9.34.		9.54.	
9.15.		9.35.		9.55.	
9.16.		9.36.		9.56.	
9.17.		9.37.		9.57.	
9.18.		9.38.		9.58.	
9.19.		9.39.		9.59.	
9.20.		9.40.		9.60.	

# Language

## 10. - Language

10. Exit language	
10.1. Deutsch	
10.2. English	

Menu “10. Language” can be used to select the language for the menu guidance. This is queried automatically during initial commissioning. The choice of languages may differ, however, depending on the device design. Language selection is not available in every device design!



# Malfunctions

## Z.1 Malfunctions with error messages

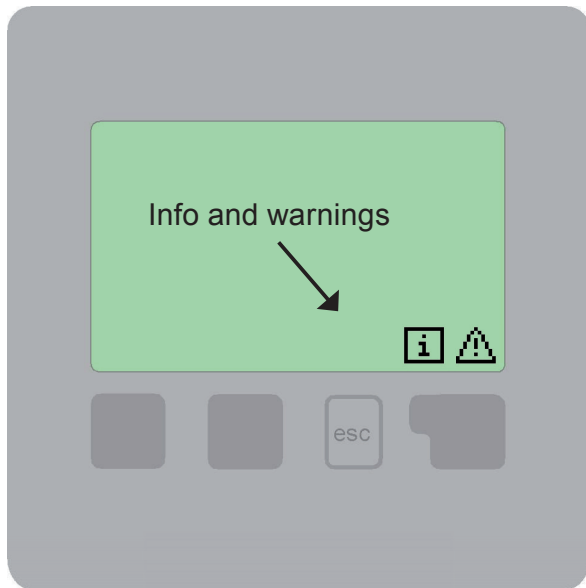

If the controller detects a malfunction, the red light flashes and the warning symbol also appears in the display. If the error is no longer present, the warning symbol changes to an info symbol and the red light no longer flashes. To obtain more detailed information on the error, press the key under the warning or info symbol.



Do not try to deal with this yourself. Consult a specialist in the event of an error!

Error messages:	Notes for the specialist:
Sensor x defective	Either the sensor, the sensor input at the controller or the connecting cable is/was defective. (Resistance table on page 5)
Collector alarm	The collector has exceeded the temperature set under menu 6.5
On / Off too often	The solar pump was switched more than 6 times in 5 minutes.
Restart	The controller was restarted, for example due to a power failure. Check the date&time!

# Fuse

## Z.2 Replacing the fuse



Repairs and maintenance may only be performed by a specialist. Before working on the unit, switch off the power supply and secure it against being switched on again! Check for the absence of power!



Only use the supplied spare fuse or a fuse of the same design with the following specifications: T2A 250V

### Z.2.1

Fuse

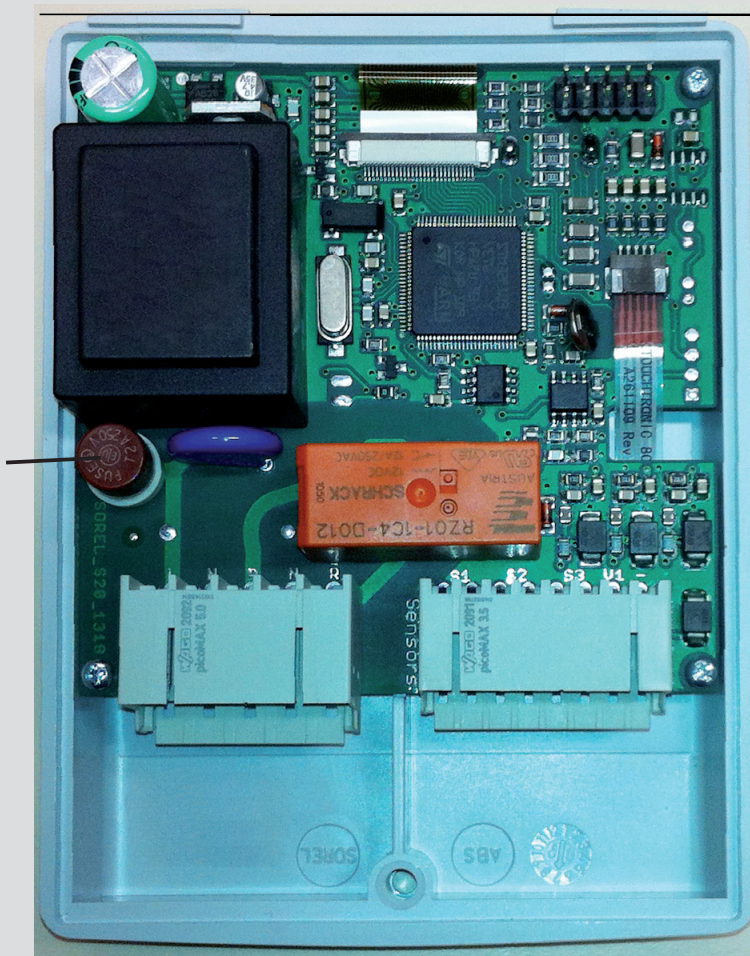

If the mains voltage is switched on and the controller still does not function or display anything, then the internal device fuse may be defective. In that case, open the device as described under C.1, remove the old fuse and check it. Exchange the defective fuse for a new one, locate the external source of the error (e.g. pump) and exchange it. Then first recommission the controller and check the function of the switch outputs in manual mode as described under 4.2.

# Maintenance

## Z.3. Maintenance



Caution

In the course of the general annual maintenance of your heating system you should also have the functions of the controller checked by a specialist and have the settings optimised if necessary.

Performing maintenance:

- Check the date and time (see „7.4. - Time and Date“ on page 40 )
- Assess/check plausibility of analyses (see „2. - Statistics“ on page 23)
- Check the message log (see „2.5. - Message log“ on page 23)
- Verify/check plausibility of the current measurement values (see „1. - Measurement values“ on page 22)
- Check the switch outputs/consumers in manual mode (see „4.2. - Manual“ on page 25)
- If necessary: Optimise the parameter settings

---

Hydraulic variant set:

Commissioned on:

Commissioned by:

---

Notes:

---

Final declaration:

Although these instructions have been created with the greatest possible care, the possibility of incorrect or incomplete information cannot be excluded. Subject as a basic principle to errors and technical changes.

---