

Solar controller SR34

Installation and operating instructions



Read carefully before installation, commissioning and operation

Table of content

A. - Safety instructions	4	6.1. - Program selection	30	6.4.11. - Error message	42
A.1. - EC declaration of conformity	4	6.2. - Pump menu	30	6.4.12. - Pressure monitor	43
A.2. - General instructions	4	6.2.1. - Type of pump	30	6.4.12.1. - Pressure monitor	43
A.3. - Explanation of symbols	4	6.2.2. - Pump	30	6.4.12.2. - RPS1 / RPS2	43
A.4. - Changes to the unit	5	6.3. - Speed control R1 / R2	31	6.4.12.3. - Pmin	43
A.5. - Warranty and liability	5	6.3.1. - Modes	31	6.4.12.4. - Pmax	43
B. - Description of controller	6	6.3.3. - Purging time	31	6.4.13. - Booster pump	43
B.1. - Specifications	6	6.3.2. - Sweep time	31	6.4.13.1. - Filling time	43
B.2. - Temperature resistance table		6.3.4. - max. speed	32	6.4.14. - Parallel operation R (X)	44
for Pt1000 sensors	7	6.3.5. - min. speed	32	6.4.14.1. - Delay	44
B.3. - About the controller	7	6.3.6. - Setpoint	32	6.4.14.2. - Followup time	44
B.4. - Scope of supply	7	6.4. - Relay functions	33	6.4.15. - Always on	44
B.5. - Disposal and pollutants	7	6.4.1. - Solar bypass	33	6.4.16. - Heating circuit	44
C. - Installation	8	6.4.1.1. - Variant	33	6.4.16.1. - Room set day	44
C.1. - Electrical connection	8	6.4.1.2. - Bypass (sensor)	33	6.4.16.2. - Room set night	44
C.2. - Wall instalion	9	6.4.2. - Thermostat	34	6.4.16.3. - Room sensor	44
C.3. - Installing the		6.4.2.1. - TH Set	34	6.4.16.4. - Periods	44
temperature sensors	11	6.4.2.2. - TH hysteresis	34	6.5. - Heat quantity	45
D. - Terminal connection	12	6.4.2.3. - Thermostat sensor 1	34	6.5.1. - Constant flow	45
D.1. - Terminal connection diagram	12	6.4.2.4. - Thermostat sensor 2	34	6.5.1.1. - Flow sensor (X)	45
D.2. - Hydraulic variants / systems	13	6.4.2.5. - T eco	34	6.5.1.2. - Return sensor	45
E. - Operation	19	6.4.1.3. - Storage	34	6.5.1.3. - Anti freeze type	45
E.1. - Display and input	19	6.4.3.1. - Energy saving mode	35	6.5.1.4. - Glycole percentage	45
E.2. - Commissioning help	20	6.4.3.2. - Periods	35	6.5.1.5. - Flow rate (X)	45
E.3. Free commissioning	20	6.4.3. - Thermostat 2	35	6.5.1.6. - Offset ΔT	45
E.4. Menu sequence	21	6.4.4. - Cooling	36	6.5.2. - VFS (X)	46
1. - Measurement values	22	6.4.4.1. - Co T set	36	6.5.2.1. - VFS Typ	46
2. - Statistics	23	6.4.4.2. - Co hysteresis	36	6.5.2.2. - VFS - Position	46
2.1. - Operating hours	23	6.4.4.3. - Cooling (sensor)	36	6.5.2.3. - Reference sensor	46
2.2. - Heat output	23	6.4.4.4. - Periods	36	6.6. - Pressure monitor	46
2.3. - Graphic overview	23	6.4.5. - Return flow increase	37	6.6.1. - Pressure monitor	46
2.5. - Message log	23	6.4.5.1. - RF Tmax	37	6.6.1.1. - RPS1 / RPS2	46
2.4. - Reset/clear	23	6.4.5.2. - ΔT return flow	37	6.6.1.2. - Pmin	46
3. - Operating modes	24	6.4.5.3. - Return flow (sensor)	37	6.6.1.3. - Pmax	46
3.1. - Automatic	24	6.4.5.4. - Storage (sensor)	37	6.7. - Sensor calibration	47
3.2. - Manual	24	6.4.6. - Collector field cooling	38	6.8. - Commissioning	47
3.3. - Off	24	6.4.6.1. - Tmax field	38	6.9. - Factory settings	47
4. - Settings	25	6.4.6.2. - Hys min	38	6.10. - Start aid function	47
4.1. - Tmin S (X)	25	6.4.6.3. - Hys max	38	6.11. - Time and date	48
4.2. - Tmax S (X)	25	6.4.6.4. - Field cooling sensor	38	6.12. - Daylight saving time	48
4.3. - Tmax SB	25	6.4.7. - Anti Legionella	39	6.13. - Sleep mode	48
4.4. - Tmax SB WT	26	6.4.7.1. - AL T set	39	6.14. - Temperature unit	48
4.5. - ΔT Solar S (X)	26	6.4.7.2. - AL residence time	39	7. - Menu lock	49
4.6. - Priority S(X)	26	6.4.7.3. - Last AL heat	39	8. - Service values	49
4.7. - T-priority	26	6.4.7.4. - AL sensor 1	39	9. - Languages	49
4.8. - Loading time	26	6.4.7.5. - AL Sensor 2	39	Z.1. Malfunctions with	
4.9. - Increase	27	6.4.7.6. - AL-times	39	error messages	50
5. - Protective functions	28	6.4.8. - Heat transfer	40	Z.2 Replacing the fuse	51
5.1. - System protection	28	6.4.8.1. - ΔT Heat transfer	40	Z.3 Maintenance	52
5.2. - Collector protection	28	6.4.8.2. - Setpoint	40	J. - Appendix	53
5.3. - Recooling	29	6.4.8.3. - HT Tmin	40	J.14.1. - Pump	53
5.4. - Frost Protection	29	6.4.8.4. - HT Source (sensor)	40	J.14.2. - Output Signal	53
5.5. - Seizing protection	29	6.4.8.5. - HT Drain (Target sensor)	40	J.14.3. - PWM off	53
5.6. - Collector alarm	29	6.4.9. - Difference	41	J.14.4. - PWM on	53
6. - Special functions	30	6.4.9.1. - ΔT difference	41	J.14.5. - PWM Max	53
		6.4.9.2. - DF source (sensor)	41	J.17.3 - 0-10V off	53
		6.4.9.3. - Diff Tmin	41	J.17.4 - 0-10V on	53
		6.4.9.4. - DF Drain (sensor)	41	J.17.5 - 0-10V Max	53
		6.4.9.5. - DF Tmax	41	J.14.6. - Speed when „On“	53
		6.4.10. - Solid fuel boiler	42	J.14.7. - Show signal	53
		6.4.10.1. - SF Tmin	42		
		6.4.10.2. - ΔT Solid fuel	42		
		6.4.10.3. - SF Tmax	42		
		6.4.10.4. - Boiler sensor	42		
		6.4.10.5. - Storage sensor	42		

This manual applies to the following hardware versions:

Version 1

3 mechanical relays (2 on/off, 1 changeover contact)
1 PWM / 0-10V for high efficiency pumps
5 PT1000 temperature sensor inputs

Version 2

2 mechanical relays (1 on/off, 1 change-over contact)
1 electronic relay
for speed control of standard pumps
1 PWM / 0-10V for high efficiency pumps
5 PT1000 temperature sensor inputs

Version 3

3 mechanical relays (2 on/off, 1 changeover contact)
2 PWM / 0-10V for high efficiency pumps
6 PT1000 temperature sensor inputs
2 VFS / RPS direct sensor inputs

Version 4

1 mechanical relay (change-over contact)
2 electronic relays
for speed control of standard pumps
2 PWM / 0-10V for high efficiency pumps
6 temperature sensor inputs
2 VFS / RPS direct sensor inputs

When you are unsure which version you have, check the type label on the side of the controller.

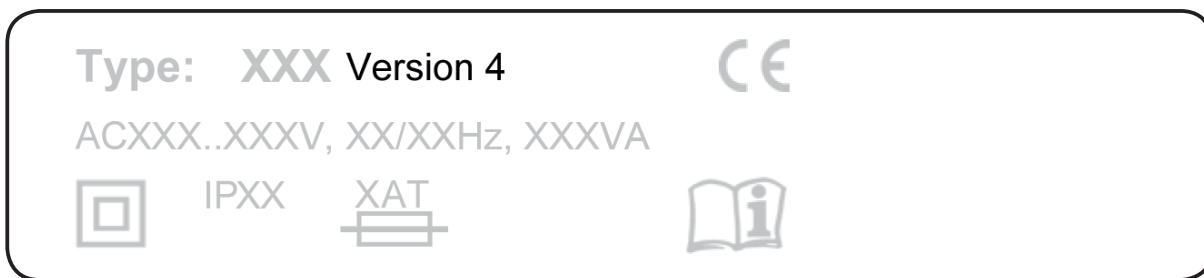

If the version is not readable here, open the controller's "Service values" menu. The version is shown in the first line of the service values.

Safety instructions

A.1. - EC declaration of conformity

By affixing the CE mark to the unit the manufacturer declares that the SR34 conforms to the following relevant safety regulations:

- EC low voltage directive 2006/95/EC
- EC electromagnetic compatibility directive 2004/108/EC

Conformity has been verified and the corresponding documentation and the EC declaration of conformity are kept on file by the manufacturer.

A.2. - General instructions

These installation and operating instructions contain basic instructions and important information regarding safety, installation, commissioning, maintenance and the optimal use of the unit. Therefore these instructions must be read completely and understood by the installation technician/specialist and by the system user before installation, commissioning and operation of the unit.

The valid accident prevention regulations, VDE regulations, the regulations of the local power utility, the applicable DIN-EN standards and the installation and operating instruction of the additional system components must also be observed. The controller does not under any circumstances replace any safety devices to be provided by the customer!

Installation, electrical connection, commissioning and maintenance of the unit may only be carried out by specialists who possess the appropriate training.

For the user: Make sure that the specialist gives you detailed information on the function and operation of the controller. Always keep these instructions in the vicinity of the controller.

A.3. - Explanation of symbols



Failure to observe these instructions can result in danger to life from electric voltage.



Failure to observe these instructions can result in serious damage to health such as scalding, or even life-threatening injuries.



Failure to observe these instructions can result in destruction of the unit or the system, or damage to the environment.



Information which is especially important for the function and optimal use of the unit and the system.

Description of controller

A.4. - Changes to the unit

- Changes, additions to or conversion of the unit are not permitted without the written permission from the manufacturer
- It is likewise forbidden to install additional components that have not been tested together with the unit
- If it becomes clear that safe operation of the unit is no longer possible, for example because of damage to the housing, then turn the controller off immediately
- Any parts of the unit or accessories that are not in perfect condition must be exchanged immediately
- Use only original spare parts and accessories from the manufacturer.
- Markings made on the unit at the factory must not be altered, removed or made illegible
- Only the settings actually described in these instructions may be made on the controller



Changes to the unit can compromise the safety and function of the unit or the entire system.

A.5. - Warranty and liability

The controller has been manufactured and tested with regard to high quality and safety requirements. The unit is subject to the statutory guarantee period of two years from the date of sale.

The warranty and liability shall not include, however, any injury to persons or material damage that is attributable to one or more of the following causes:

- Failure to observe these installation and operating instructions
- Improper installation, commissioning, maintenance and operation
- Improperly executed repairs
- Unauthorised structural changes to the unit
- Installation of additional components that have not been tested together with the unit
- Any damage resulting from continued use of the unit despite an obvious defect
- Failure to use original spare parts and accessories
- Use of the device for other than its intended purpose
- Operation above or below the limit values listed in the specifications
- Force majeure

Description of controller

B.1. - Specifications

Electrical specifications:

Mains voltage	100 - 240VAC
Mains frequency	50 - 60Hz
Power consumption	0,5W - 2,5W
Internal fuse	T2A / 250V slow blow
Protection category	IP40
Protection class	II
Overvoltage Category	II
Degree of Pollution Category	II

	Vers.1	Vers.2	Vers.3	Vers.4														
mechanical relay 460VA for AC1 / 460W for AC3	3 (R1-R3)	2 (R2-R3)	3 (R1-R3)	1 (R3)														
electronic relay min.5W...max.120W for AC3	-	1 (R1)	-	2(R1-R2)														
0-10V output, tolerance 10%, 10 k Ω load or PWM output freq. 1 kHz, level 10 V	1	1	2	2														
PT1000 sensor input measuring range -40°C to 300°C	5	5	6	6														
VFS / RPS inputs 0°C-100°C (-25°C /120°C short term)		-	2	2														
<table border="0"> <tr> <td>1 l/min - 12 l/min (VFS1-12)</td> <td>0-0,6 bar</td> </tr> <tr> <td>2 l/min - 40 l/min (VFS2-40)</td> <td>0-1 bar</td> </tr> <tr> <td>5 l/min - 100 l/min (VFS5-100)</td> <td>0-1,6 bar</td> </tr> <tr> <td>10 l/min - 200 l/min (VFS10-200)</td> <td>0-2,5 bar</td> </tr> <tr> <td></td> <td>0-4 bar</td> </tr> <tr> <td></td> <td>0-6 bar</td> </tr> <tr> <td></td> <td>0-10 bar</td> </tr> </table>	1 l/min - 12 l/min (VFS1-12)	0-0,6 bar	2 l/min - 40 l/min (VFS2-40)	0-1 bar	5 l/min - 100 l/min (VFS5-100)	0-1,6 bar	10 l/min - 200 l/min (VFS10-200)	0-2,5 bar		0-4 bar		0-6 bar		0-10 bar				
1 l/min - 12 l/min (VFS1-12)	0-0,6 bar																	
2 l/min - 40 l/min (VFS2-40)	0-1 bar																	
5 l/min - 100 l/min (VFS5-100)	0-1,6 bar																	
10 l/min - 200 l/min (VFS10-200)	0-2,5 bar																	
	0-4 bar																	
	0-6 bar																	
	0-10 bar																	

Network connections

CAN Bus

Permissible cable length of sensors and appliances:

Collector and outdoor sensor	<30m
other PT1000 sensors	<10m
VFS/RPS Sensoren	<3m
CAN	<3m
PWM / 0...10V	<3m
electronic relay	<3m
mechanical relay	<10m

Real Time Clock

RTC with 24 hour power reserve

Permissible ambient conditions:

Ambient temperature	
for controller operation	0°C...40°C
for transport/storage	0°C...60°C
Air humidity	
for controller operation	max. 85% rel. humidity at 25°C
for transport/storage	no moisture condensation permiddled

Other specifications and dimensions

Housing design	3-part, ABS plastic
Installation methods	Wall installation, optionally panel installation
Overall dimensions	163mm x 110mm x 52mm
Aperture installation dimensions	157mm x 106mm x 31mm
Display	Fully graphical display, 128 x 128 dots
Light diode	Multicolor red/green
Operation	4 entry keys

Description of controller

B.2. - Temperature resistance table for Pt1000 sensors

°C	0	10	20	30	40	50	60	70	80	90	100
Ω	1000	1039	1077	1116	1155	1194	1232	1270	1308	1347	1385

B.3. - About the controller

The Temperature Difference Controller SR34 facilitates efficient use and function control of your solar or heating system. The device is impressive most of all for its functionality and simple, almost self-explanatory operation. For each step in the input process the individual entry keys are assigned to appropriate functions and explained. The controller menu contains headwords for the measured values and settings, as well as help texts or clearly-structured graphics.

The SR34 can be used as a solar controller for the various system variants illustrated and explained under „D.2. - Hydraulic variants / systems“ on page 13.

Important characteristics of the SR34:

- Depiction of graphics and texts in a lighted display
- Simple viewing of the current measurement values
- Analysis and monitoring of the system by means of statistical graphics, etc.
- Individual configuration of special functions
- Extensive setting menus with explanations
- Menu block can be activated to prevent unintentional setting changes
- Resetting to previously selected values or factory settings
- A wide range of additional functions are available.

The controller is available in 4 different versions. See page 3.

B.4. - Scope of supply

- Solar controller SR34
- 3 screws 3,5x35mm and 3 plugs 6mm for wall installation
- 12 strain relief clips with 24 screws, replacement fuse 1x T2A / 250V
- Installation and instructions manual SR34

Optionally contained depending on design/order:

- PT1000 temperature sensors and immersion sleeves

Additionally available:

- Pt1000 temperature sensor, immersion sleeves, overvoltage protection,
- Data Logger with Ethernet connection

B.5. - Disposal and pollutants

The unit conforms to the European RoHS directive 2002/95/EC for the restriction of the use of certain hazardous substances in electrical and electronic equipment.



The unit must not under any circumstances be disposed of with ordinary household refuse. Dispose of the unit only at appropriate collection points or ship it back to the seller or manufacturer.

Installation

C.1. - Electrical connection



Danger

Before working on the unit, switch off the power supply and secure it against being switched on again! Check for the absence of power!
Electrical connections may only be made by a specialist and in compliance with the applicable regulations.
Do not use the controller if the housing shows visible damage.



Caution

Low-voltage cables such as temperature sensor cables must be routed separately from mains voltage cables. Feed temperature sensor cables only into the left-hand side of the unit, and mains voltage cables only into the right-hand side.



Caution

The customer must provide an all-pole disconnecting device, e.g. a heating emergency switch.



Caution

The cables being connected to the unit must not be stripped by more than 55mm, and the cable jacket must reach into the housing just to the other side of the strain relief.



Caution

Controller and VFS sensor have to have the same ground potential. The VFS sensor uses a functional earth connector (PELV). The PE-connector of the controller has to be connected to the pipe system near the sensor.

Installation

C.2. - Wall instalion



Install the controller only in dry areas and under the ambient conditions described under B.1 "Specifications".

Achtung

C.2.1.

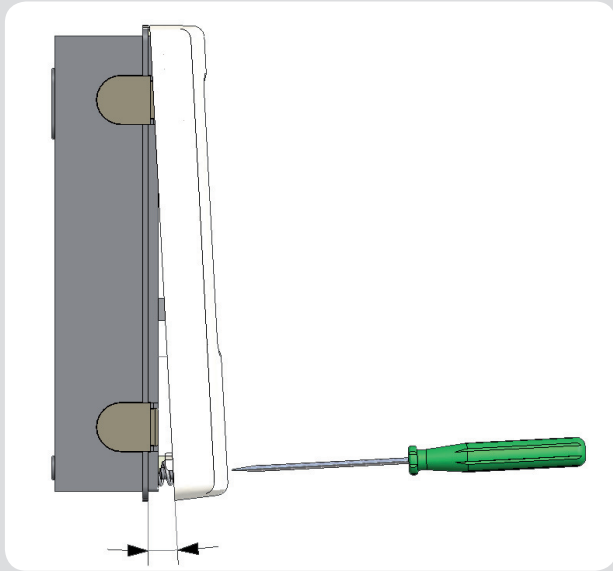

C.2.2.

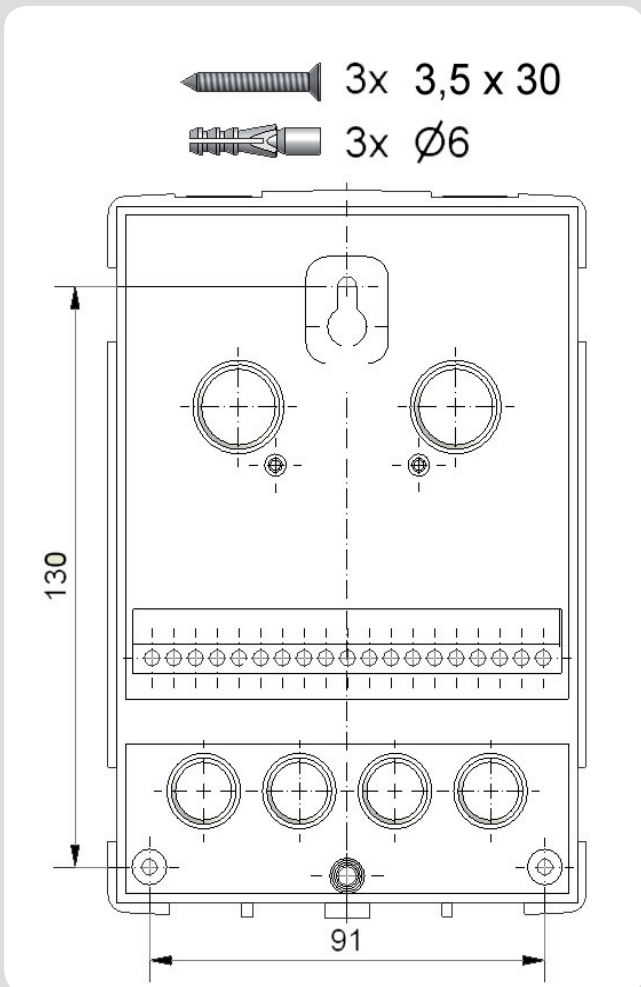

1. Unscrew cover screw completely
2. Carefully pull upper part of housing from lower part.
3. Set upper part of housing aside, being sure not to touch the electronics when doing so.
4. Hold the lower part of the housing up to the selected position and mark the 3 mounting holes. Make sure that the wall surface is as even as possible so that the housing does not become distorted when it is screwed on.
5. Using a drill and size 6 bit, drill 3 holes at the points marked on the wall and push in the plugs.
6. Insert the upper screw and screw it in slightly.
7. Fit the upper part of the housing and insert the other two screws.
8. Align the housing and tighten the three screws.



Controller must be inaccessible from the rear.

Caution

Installation

C.2.3.

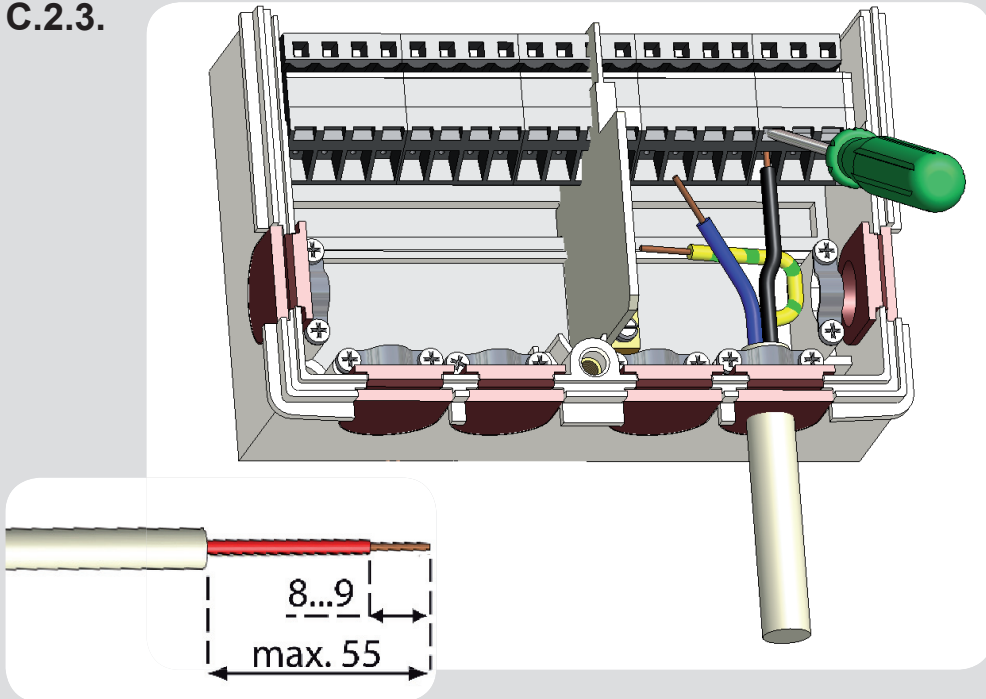

1. Select necessary program/hydraulics (s. „D.2. - Hydraulic variants / systems“ on page 13)
2. Strip cables by 55mm max., insert, fit the strain relief devices, strip the last 8-9mm of the wires (Fig. „C.2.3.“)
3. Open the terminals using a suitable screwdriver (Fig. „C.2.4.“) and make electrical connections on the controller
4. Refit terminal connection cover and fasten screw.
5. Switch on mains voltage and place controller in operation.

C.2.4.

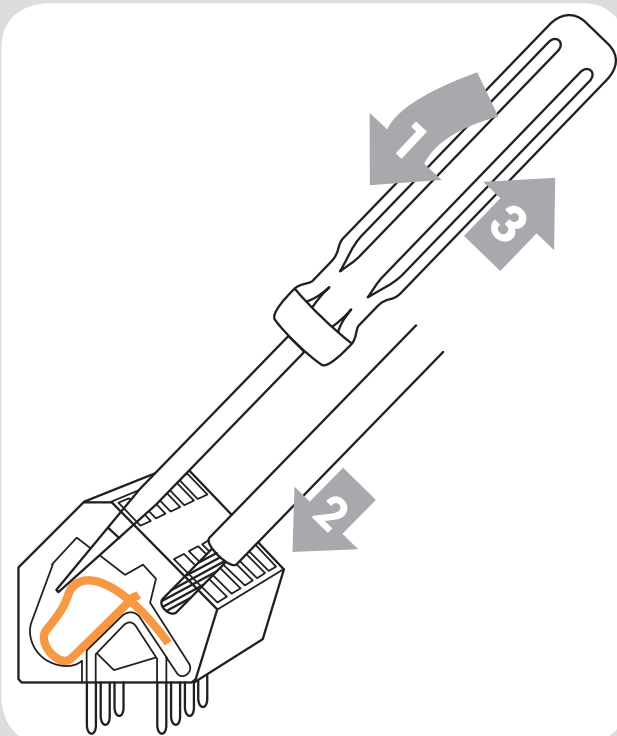

Instructions for clamps:

1. Insert screw driver into the upper hole. Push the lock clamp inside down. Keep the screw driver in this position.
2. Insert cable into the lower opening.
3. Remove screw driver. The clamp will lock the cable.

Installation

C.3. - Installing the temperature sensors

The controller operates with Pt1000 temperature sensors which are accurate to the degree, thus ensuring optimal control of system functions.



The temperature sensor cables must be routed separately from mains voltage cables, and must not, for example, be routed in the same cable duct!



Sensor cables for S1 and S5 can be extended to a maximum of 30m using a cable with a cross-section of at least 0.75mm². Sensor cables for S2 to S4 and S6 can be extended to a maximum of 10m using a cable with a cross-section of at least 0.75mm². Make sure that there is no contact resistance!



Position the sensor precisely in the area to be measured!
Only use immersion, pipe-mounted or flat-mounted sensor suitable for the specific area of application with the appropriate permissible temperature range.



Connect the VFS sensors with the matching jacks.
To prevent damage to the Direct Sensors it is highly recommended to install them in to the return.
When installing the Vortex Flow Sensors (VFS), observe the correct flow direction!

Installation

D.1. - Terminal connection diagram



max. 12V

Caution



mains side
100-240VAC

Danger

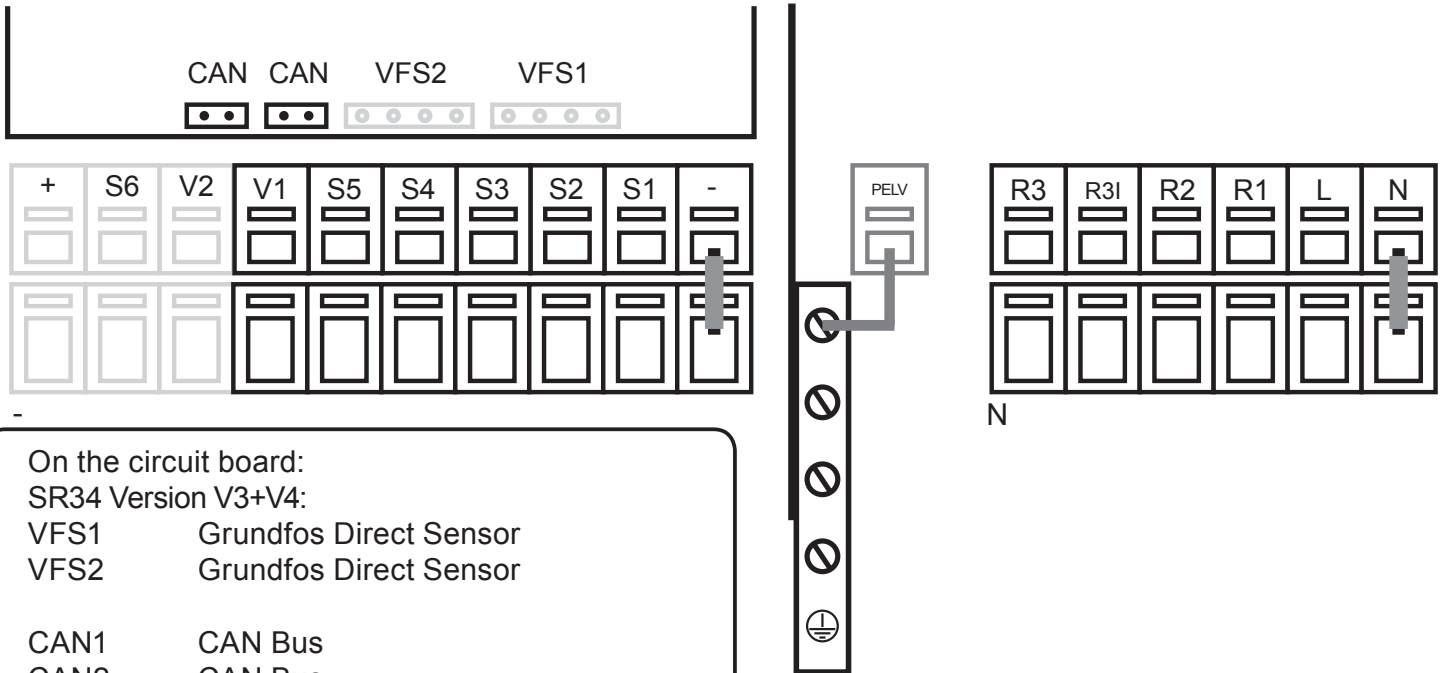

On the circuit board:

SR34 Version V3+V4:

VFS1 Grundfos Direct Sensor

VFS2 Grundfos Direct Sensor

CAN1 CAN Bus

CAN2 CAN Bus

Low voltage max. 12VAC/DC

Terminal: Connection for:

S1 Temperature sensor 1

S2 Temperature sensor 2

S3 Temperature sensor 3

S4 Temperature sensor 4

S5 Temperature sensor 5

V1 0-10V / PWM signal output
e.g. for control of High Efficiency
pumps

SR34 Version V3+V4:

V2 0-10V / PWM signal output
e.g. for control of High Efficiency
pumps

S6 Temperature sensor 6

+ 12V power supply

Connection of sensor earth to the grey lower
terminal block.

Mains voltage 100-240VAC 50-60Hz

Terminal: Connection for:

R1 Relay 1

R2 Relay 2

R3 Relay 3 (normally open)

R3I Relay 3 (normally closed)

L Netz Außenleiter L

N Netz Neutralleiter N



The neutral conductors are connected to the
lower blue terminals



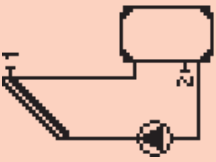
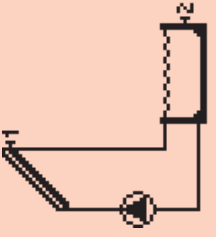
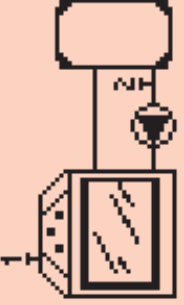
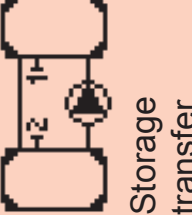
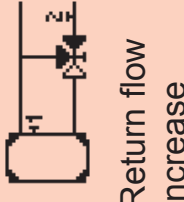

The PE protective conductor must be
connected to the PE metal terminal block!

The power supply of HE pumps with 0-10V
/ PWM pumps can be connected to the
corresponding relay (V1 -> R1, R2 -> V2), since
the relays are switched on and off with the
signal.

Installation

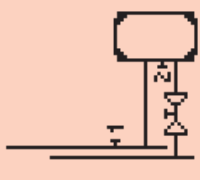
D.2. - Hydraulic variants / systems

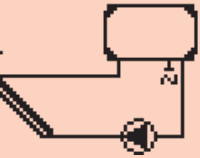
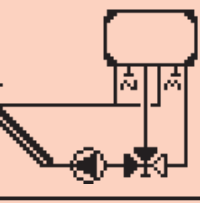
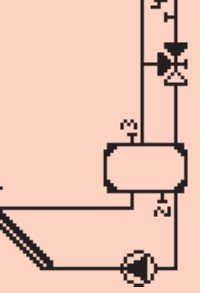
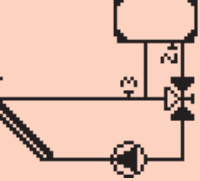
	Schema 1	Schema 2	Schema 3	Schema 4	Schema 5	Schema 6	Schema 7
	 Solar	 Solar with Pool	 Solid fuel boiler	 Storage transfer	 Return flow increase	 Thermostat	 Universal DeltaT
S1	Collector	Collector	Boiler	Storage 1	Storage top	Storage top	Source sensor
S2	Storage	Pool	Storage	Storage 2	Return	Storage bottom	Target sensor
S3							
S4							
S5							
S6							
VFS1							
VFS2							
R1 / V1	Solar pump	Solar pump	Charge pump	Pump			Pump 1
R2	-	-					
R3	-	-			Switching valve	Thermostat	

Schema 8		Solar with stop valve	Collector	Source sensor																	
Schema 9		Solar with Pool+WT-Sensor	Collector	Pool	Heat exchanger																
Schema 10		Solar + Thermostat	Collector	Storage	Thermostat																
Schema 11		Solar + 2-Zone Storage + Valve	Collector	Storage top	Storage bottom																
Schema 12		Solar + return flow increase	Collector	Storage bottom	Storage middle	Return															
Schema 13		Solar + Bypass	Collector	Storage	Bypass																
Schema 14		Solar +WT	Collector	Storage	Heat exchanger																
S1																					
S2																					
S3																					
S4																					
S5																					
S6																					
VFS1																					
VFS2																					
R1 / V1																					
R2																					
R3																					

Schema 15		Solar + 2. Collector + Valve	Collector 1	Storage	Collector 2	Solar pump	Solar pump	Switching valve
Schema 16		Solar + 2. Collector + Pump	Collector 1	Storage	Collector 2	Solar pump Koll. 1	Solar pump Koll. 2	
Schema 17		Solar + 2. storage with valve	Collector	Storage 1	Storage 2	Thermostat	Solar pump	Switching valve
Schema 18		Solar + 2. Storage + Pump	Collector	Storage 1	Storage 2		Solar pump Storage 1	Solar pump Storage 2
Schema 19		Solar + Storage transfer	Collector	Storage 1 bottom	Storage 2 top	Storage 1 top	Solar pump	Transfer pump
Schema 20		Solar with pool + WT	Collector	Pool	Heat exchanger		Solar pump	Secondary pump
Schema 21		Solar + thermostat as valve	Collector	Storage bottom	Storage top		Solar pump	Switching valve
S1			Collector					
S2			Storage					
S3								
S4								
S5			Collector 2					
S6								
VFS1								
VFS2								
R1 / V1			Solar pump				Solar pump	
R2								
R3			Switching valve					

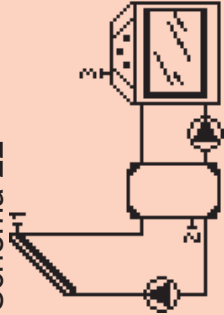
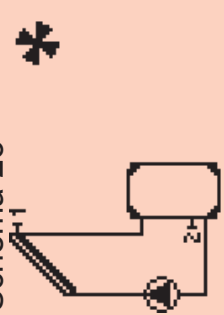
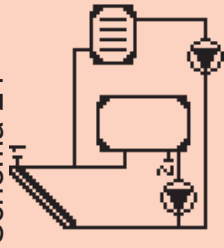
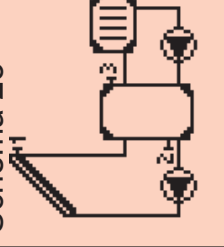
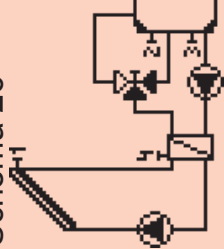
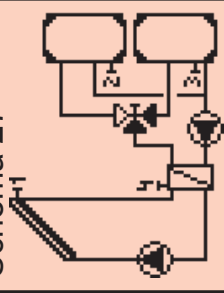
Schema 22		Solar + Solid fuel-boiler	Collector	Collector	Collector	Collector	Collector	Collector	Collector
Schema 23		Solar + cooling 1	Collector	Storage	Storage	Storage	Storage	Storage	Storage
Schema 24		Solar + cooling 2	Collector	Storage	Storage	Storage	Storage	Storage	Storage
Schema 25		Solar + cooling 3	Collector	Storage bottom	Storage top	Storage top	Storage top	Storage top	Storage top
Schema 26		Solar + WT + zone storage + valve	Collector	Storage top	Storage bottom	Storage bottom	Storage bottom	Storage bottom	Storage bottom
Schema 27		Solar + WT + 2 storage with valve	Collector	Storage 1	Storage 2	Storage 2	Storage 2	Storage 2	Storage 2
S1			Collector						
S2			Storage	Storage	Storage	Storage	Storage	Storage	Storage
S3			Solid fuelBoiler						
S4									
S5									
S6									
VFS1									
VFS2									
R1 / V1			Solar pump	Solar pump	Solar pump	Solar pump	Solar pump	Solar pump	Solar pump
R2			Solid fuelboiler pump						
R3				Cooler					

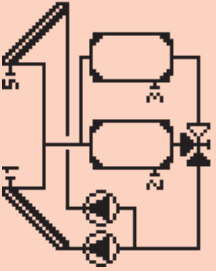
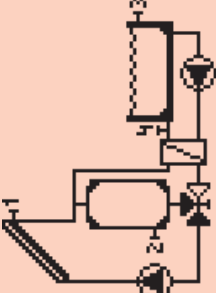
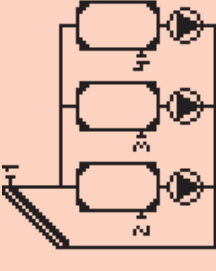
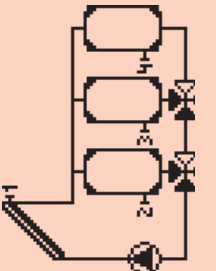
Schema 34		Solar+2.Collector with Pump+2.Storage with Valve
S1	Collector1	Collector
S2	Storage 1	Storage 1
S3	Storage 2	Storage 2
S4		Heat exchanger (secondary)
S5	Collector 2	
S6		
VFS1		
VFS2		
R1 / V1	Solar pump 1	Solar pump
R2	Solar pump 2	Secondary pump
R3	Switching valve	Switching valve
Schema 35		Solar+Valve for Pool+WT
S1	Collector	Collector
S2	Storage	Storage 1
S3	Pool	Storage 2
S4		Storage 3
S5		
S6		
VFS1		
VFS2		
R1 / V1	Solar pump	Solar pump 1
R2	Secondary pump	Solar pump 2
R3	Switching valve	Solar pump 3
Schema 36		Solar+3 Storage with Pumps
S1	Collector	Collector
S2	Storage 1	Storage 1
S3	Storage 2	Storage 2
S4	Storage 3	Storage 3
S5		
S6		
VFS1		
VFS2		
R1 / V1	Solar pump 1	Solar pump
R2	Solar pump 2	Switching valve 1 (1 or 2/3)
R3	Solar pump 3	Switching valve 2 (2 or 3)
Schema 37		Solar+3 Storage with Valves
S1	Collector	Collector
S2	Storage 1	Storage 1
S3	Storage 2	Storage 2
S4	Storage 3	Storage 3
S5		
S6		
VFS1		
VFS2		
R1 / V1	Solar pump	Solar pump
R2	Switching valve 1 (1 or 2/3)	Switching valve 1 (1 or 2/3)
R3	Switching valve 2 (2 or 3)	Switching valve 2 (2 or 3)

Operation

E.1. - Display and input

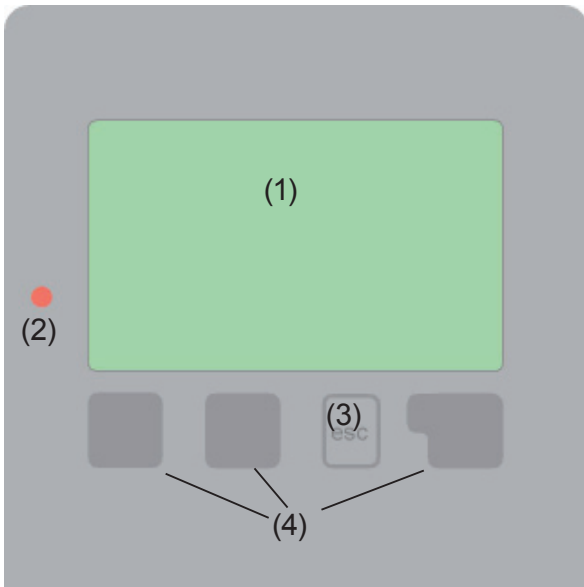

The display (1), with its extensive text and graphics mode, is almost self-explanatory, allowing easy operation of the controller.

To change from the overview to the settings menu, press the „esc“ key.

The green status LED (2) lights up when a relay is active, the red LED blinks when an error occurs.











Inputs are made with 4 buttons (3+4), which functions change context sensitive.

The „esc“ key (3) is always used to cancel or exit a menu.

If applicable there will be a request for confirmation as to whether the changes which have been made should be saved.

The function of each of the other three keys (4) is shown in the display line directly above the keys; the right-hand key is generally has a confirmation and selection function.

Examples of display symbols:

	Pump (rotates in operation)
	Valve (direction of flow in black)
	Collector
	Storage
	Pool
	Temperature sensor
	Heat exchanger
	Load pause (see Load time)
	Warning / error message
	New information available
	Logging is active

More symbols can be found in the chapter „Special functions“

Examples of key functions:

+/-	= enlarge/shrink values
▼/▲	= scroll menu down/up
yes/no	= approve/reject
Info	= additional information
Back	= to previous screen
ok	= confirm selection
Confirm	= confirm setting

Operation

E.2. - Commissioning help



The first time the controller is turned on and after the language and time are set, a query appears as to whether you want to parametrise the controller using the commissioning help or not. The commissioning help can also be terminated or called up again at any time in the special functions menu. The commissioning help guides you through the necessary basic settings in the correct order, and provides brief descriptions of each parameter in the display.

Pressing the “esc” key takes you back to the previous value so you can look at the selected setting again or adjust it if desired. Pressing the “esc” more than once

takes you back step by step to the selection mode, thus cancelling the commissioning help. Finally, menu „3.2. - Manual“ on page 24 should be used to test the switch outputs with the consumers connected, and to check the sensor values for plausibility. Then switch on automatic mode.



Caution

Observe the explanations for the the individual parameters on the following pages, and check whether further settings are necessary for your application.

E.3. - Free commissioning

If you decide not to use the commissioning help, you should make the necessary settings in the following sequence:

- Menu 9. Language, page 49
- Menu 6.23 Time and Date, page 48
- Menu 6.1 Programmwahl, page 30
- Menu 4. Settings, all values, page 25
- Menu 5. Protective functions, if necessary, page 28
- Menu 6. Special functions, if necessary, page 30

Finally, menu „3.2. - Manual“ on page 24 should be used to test the switch outputs with the consumers connected, and to check the sensor values for plausibility. Then switch on automatic mode.



Caution

Observe the explanations for the the individual parameters on the following pages, and check whether further settings are necessary for your application.

Operation

E.4. - Menu sequence and menu structure

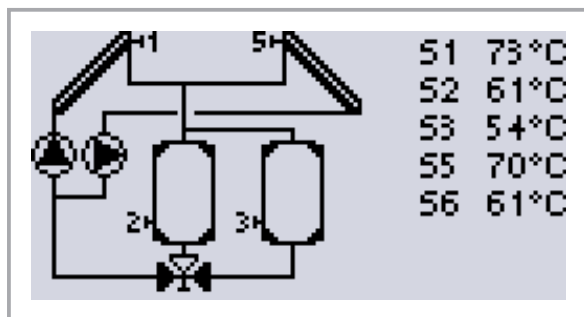

The graphics or overview mode appears when no key has been pressed for 2 minutes, or when the main menu is exited by pressing "esc".

The up and down buttons are used to scroll through the list of sensors and relays .



You can enter the Main menu by pressing the „esc“ key. The following menus are available:

1. Measurements

Current temperature values with explanations

2. Statistics

Function control of the system with operating hours, etc

3. Operating mode

Automatic mode, manual mode or switch unit off

4. Settings

Set parameters needed for normal operation

5. Protections

Solar and frost protection, recooling, anti-seizing protection

6. Special functions

Program selection, sensor calibration, clock, additional sensor, etc.

7. Menu lock

Against unintentional setting changes at critical points

8. Service Data

For diagnosis in the event of an error

9. Language

Language selection

Measurement values

1. - Measurement values

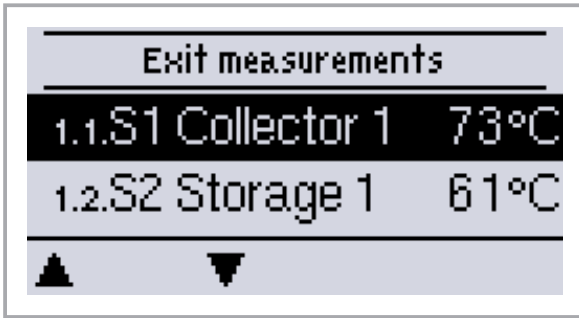

The menu "1. Measurement values" serves to display the currently measured temperatures.

The menu is closed by pressing "esc" or selecting "Exit measurement values".

Selecting "Overview" or "esc" exits the Info mode.



Caution

If "--" appears on the display instead of the measurement value, then there may be a defective or incorrect temperature sensor. If the cables are too long or the sensors are not placed optimally, the result may be small deviations in the measurement values. In this case the display values can be compensated for by making entries on the controller. Follow the instructions under „6.7. - Sensor calibration“ on page 47.

What measurement values are displayed depends on the selected program, the connected sensors and the specific device design.

Statistics

2. - Statistics

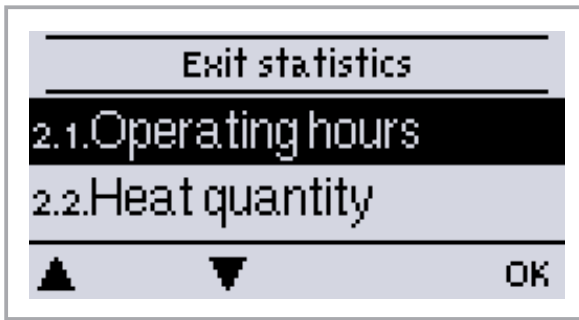

The menu “2. Statistics” is used for function control and long-term monitoring of the system.

The menu is closed by pressing “esc” or selecting “Exit statistics”.



Caution

For analysis of the system data it is essential for the time to be set accurately on the controller. Please note that the clock does not continue to run if the mains voltage is interrupted, and must therefore be reset. Improper operation or an incorrect time may result in data being deleted, recorded incorrectly or overwritten.
The manufacturer accepts no liability for the recorded data!

2.1. - Operating hours

Display of operating hours of the solar pump connected to the controller; various time ranges (day-year) are available.

2.2. - Heat output

Display of the heat output of the system. See also „6.5. - Heat quantity“ on page 45

2.3. - Graphic overview

This provides a clearly-organised display of the data listed under 2.1-2.2 as a bar graph. Various time ranges are available for comparison. The two left-hand keys can be used to page through the data.

2.4. - Message log

Display of the last 20 events occurring in the system with indication of date and time.

2.5. - Reset/clear

Resetting and deleting the individual analyses. The function “All statistics” clears all analyses but not the error messages.

Operating modes

3. - Operating modes

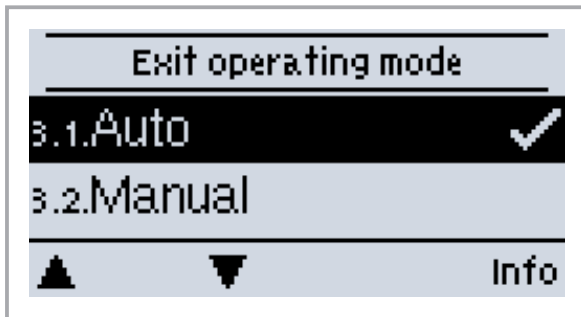

In menu “3. Operating modes” the controller can either be placed in automatic mode, switched off, or placed in a manual operating mode.

The menu is closed by pressing “esc” or selecting “Exit operating modes”.

3.1. - Automatic

Automatic mode is the normal operating mode of the controller. Only automatic mode provides proper controller function taking into account the current temperatures and the parameters that have been set! After an interruption of the mains voltage the controller automatically returns to the last operating mode selected!

3.2. - Manual

The relay and thus the connected consumer are switched on and off by pressing a key, with no regard to the current temperatures and the parameters which have been set. The measured temperatures are also shown to provide an overview and function control.



Danger

When operating mode “Manual” is activated, the current temperatures and the selected parameters are no longer considered. There is a danger of scalding or serious damage to the system. The operating mode “Manual” may only be used by specialists for brief function tests or during commissioning!

3.3. - Off



Caution

When the operating mode “Off” is activated, all controller functions are switched off. This can lead, for example, to overheating on the solar collector or other system components. The measured temperatures are still displayed to provide an overview.

Settings

4. - Settings



The necessary basic settings required for the control function are made in menu "4. Settings".



This does not under any circumstances replace the safety facilities to be provided by the customer!

The menu is closed by pressing "esc" or selecting "Exit settings".



The following pages contain generally valid descriptions for the settings. Enumerations may vary .

4.1. - Tmin S (X)

Enable/start temperature at sensor X:

If this value is exceeded at the applicable sensor X and the other conditions are also met, then the controller switches on the associated pump and/or valve. If the temperature at the sensor drops below this value by 5°C, then the pump and/or the valve are switched off again.

Settings range : 0°C to 99°C / Default setting: 20°C

4.2. - Tmax S (X)

Switch-off temperature at sensor X

If this value is exceeded at the applicable sensor X, the controller switches the associated pump and/or valve off. If the temperature falls below this value again and the other conditions are also met, then the controller switches the pump and/or valve on again.

Settings range: 0°C to 99°C / Default setting: 60°C



Temperature values that are set too high can lead to scalding or damage to the system. Scalding protection must be provided by the customer!

4.3. - Tmax SB

Switch-off temperature at pool sensor

If this value is exceeded at the applicable sensor, the controller switches the associated pump and/or valve off. If the temperature falls below this value again and the other conditions are also met, then the controller switches the pump and/or valve on again.

Settings range: 0°C to 50°C / Default setting: 28°C



Temperature values that are set too high can lead to scalding or damage to the system. Scalding protection must be provided by the customer!

Settings

4.4. - Tmax SB WT

Switch-off temperature at heat exchanger sensor

If this value is exceeded at the applicable sensor, the controller switches the associated pump and/or valve off. If the temperature falls below this value again and the other conditions are also met, then the controller switches the pump and/or valve on again.

Settings range: 0°C to 50°C / Default setting: 28°C



Temperature values that are set too high can lead to scalding or damage to the system. Scalding protection must be provided by the customer!

4.5. - ΔT Solar S (X)

Switch-on/switch-off temperature difference for sensor X :

If this temperature difference between the reference sensors is exceeded and the other conditions are also met, then the controller switches the applicable relay on. When the temperature drops to ΔT Off, then the relay is switched off.

Settings range: ΔT from 4°C to 50°C / ΔT -Off from 2°C to 49°C

Default setting: Depends on selected hydraulic variant



If the set temperature difference is too small, this may result in ineffective operation, depending on the system and sensor positions. Special switching conditions apply for speed control (see „6.3. - Speed control R1 / R2“ on page 31)!

4.6. - Priority S(X)

Priority of Storages X

This determines the order, in which the storages are charged. If the same priority is set for 2 storages, the charging is not switched over until charging the active storage is not possible anymore.

Settings range: 1 (highest) - 3 (lowest)

4.7. - T-priority

Temperature threshold for absolute priority

In systems with multiple storage tanks, charging of the lower-priority storage tank will never take place until this set temperature setpoint at the storage tank sensor of the highest-priority storage tank is exceeded.

Setting range: from 0°C to 90°C/default setting: 40°C

4.8. - Loading time

Interruption of charging into the lower priority storage tank

The charging of the lower-priority storage tank is interrupted after the settable time in order to check whether the collector has reached a temperature level that allows charging in the higher-priority storage tank. If so, the priority storage tank is charged.

If not, the increase is measured (see „4.9. - Increase“), to check if charging of the priority storage tank will be possible shortly.

Setting range: from 1 to 90 minutes/default setting: 20 minutes

Settings

4.9. - Increase

Extension of the charging pause due to temperature increase in the collector

For precise setting of the charging priorities for systems with multiple storage tanks, the necessary temperature increase of the collector at which the interruption of the charging into the lower-priority storage tank is extended by one minute is set here. The interruption is extended because the temperature increase of the collector is expected to enable charging in the higher-priority storage tank soon.

As soon as ΔT conditions are met, the priority storage tank is charged. If the rise in temperature falls below the set value, then the charging of the lower-priority storage tank is enabled again.

Setting range: from 1°C to 10°C/default setting: 3°C

Protections

5. - Protections / Protective functions



Menu „5. - Protections / Protective functions“ can be used to activate and set various protective functions.



This does not under any circumstances replace the safety facilities to be provided by the customer!

The menu is closed by pressing “esc” or selecting “Exit”.

5.1. - System protection

Highest Priority Protection

System protection prevents overheating of system components by automatic shutdown of the solar pump. If “SProt Ton” is exceeded for 1 minute at the collector, the pump is switched off and stays off. The pump is activated again when the temperature drops below “SProt TOff”.

System protection - Settings range: ON / OFF / Default setting: On

SP T on - Settings range: 60 °C to 150 °C / Default setting: 120 °C

SP T off - Settings range: 50 °C to T on minus 5 °C / Default setting: 115 °C



When system protection is on, the temperature in the idle collector will be very high, thus the pressure in the system will rise and can damage your system. Pay close attention to the instructions of the system manufacturer.

5.2. - Collector protection

Collector protection prevents overheating of the collector. The pump is switched on to transfer heat from the collector to the storage tank.

If “CP Ton” is exceeded at the collector sensor, the pump is switched on until the temperature reaches “CP Toff” or the temperature “CP Tmax storage” is exceeded in the storage or pool.

Collectorprotection - Settings range: On / Off / Default setting: Off

CP T on - Settings range: 60°C to 150°C / Default setting: 110°C

CP T off - Settings range: 50°C to T on minus 5°C / Default setting: 100°C

CP Storage S(x) Max - Settings range: 30°C to 140°C / Default setting: 90°C



When collector protection is active, and both storage and pool are present, the storage is heated up to „CP Storage S(x) Max“ beyond Tmax S2 (see „4.2. - Tmax S (X)“ on page 25) which can result in scalding and system damage. When only a pool is used, the pool is not used for collector protection.



System protection has a higher priority than collector protection. Even when the switch on conditions for collector protection are present, the solar pump will be switched off when SP T on is reached.

Protective functions

5.3. - Recooling

In hydraulic systems with solar when the recooling function is activated excess energy from the storage tank is fed back into the collector. This only takes place if the temperature in the storage tank is higher than the value "Recool Tsetpoint" and the collector is at least 20°C cooler than the storage tank and before the storage tank temperature has dropped below the value "Recool Tsetpoint". In systems with two storage tanks the setting applies to both storage tanks.

Recooling - Settings range: On, Off / Default setting: Off

Recooling Tref - Settings range: 0°C to 99°C / Default setting: 70°C



Caution

Energy is lost via the collector when Recooling is active! Recooling should only be active in periods with very little demand for heat e.g. during longer absence / holidays.

5.4. - Frost Protection

A two-stage frost protection function can be activated. In stage 1 the controller switches the pump on for 1 minute every hour if the collector temperature drops below the set value "Frost stage 1".

If the collector temperature drops further to the set value "Frost stage 2" the controller switches the pump on continuously.

If the collector temperature then exceeds the value "Frost stage 2" by 2°C, then the pump switches off again.

Frost protection setting range: on, off/default setting: off

Frost stage 1 setting range: from -25°C to 10°C or off/default setting: 7°C

Frost stage 2 setting range: from -25°C to 8°C/default setting: 5°C



Caution

This function causes energy to be lost via the collector! It is normally not activated for solar systems with antifreeze.

Observe the operating instructions for the other system components!

5.5. - Seizing protection

If the seizing protection is activated, the controller switches the relay in question and the connected consumer on every day at 12:00 (setting "daily") or weekly on Sundays at 12:00 (setting "weekly") for 5 seconds in order to prevent the pump and/or the valve from sticking after an extended stationary period.

Setting range R1: daily, weekly, off/default setting: Off

Setting range R2: daily, weekly, off/default setting: Off

Setting range R3: daily, weekly, off/default setting: Off

5.6. - Collector alarm

If this temperature is exceeded at the collector sensor when the solar pump is on a warning or error message is triggered. A warning message is shown in the display.

Collector alarm - Settings range: On / Off / Default setting: Off

Collector Tmax - Settings range: 60 °C to 299 °C / Default setting: 115 °C

Delay settings range: 1 - 60 minutes / Default: 1 minute

Special functions

6. - Special functions



Menu "7. Special functions" is used to set basic items and expanded functions.



Other than the time all settings may only be made by a specialist.

The menu is closed by pressing "esc" or selecting "Exit special functions".



Caution

The enumeration of the menus may vary from system to system.

6.1. - Program selection

The suitable hydraulic variant for the specific application is selected and set here (see „D.2. - Hydraulic variants / systems“ on page 13). The associated diagram is displayed.

Settings range: 1-37 / Default setting: 1



Caution

Normally the program selection is made only once during initial commissioning by the specialist. Incorrect program selection can lead to unpredictable errors.



Caution

If the program is changed, the settings revert to factory settings.

6.2. - Pump menu

This menu contains the settings for 0-10V or PWM pump.



Caution

The power supply of HE pumps with 0-10V / PWM pumps can be connected to the corresponding relay (V1 -> R1, R2 -> V2), since the relays are switched on and off with the signal.

6.2.1. - Type of pump

The type of speed controlled pump must be entered here.

Standard: Speed control for standard pumps.

0-10V: Speed control of e.g. High efficiency pumps by 0-10V signal.

PWM: Speed control of e.g. High efficiency pumps by PWM signal.

6.2.2. - Pump

In this menu, preconfigured profiles for various pumps can be selected. Please note that individual settings are still possible even when a profile has been selected.

For manual settings, see „J. - Appendix“ on page 53

Special functions

6.3. - Speed control R1 / R2

With speed control the SR34 makes it possible to vary the speed of connected pumps.



This function should only be activated by a specialist. Depending on the pump and pump stage used, the minimum speed should not be set too low, because otherwise the pump or the system may be damaged. The information provided by the relevant manufacturer must also be observed! If in doubt, the min. speed and the pump stage should generally be set to high rather than too low.

6.3.1. - Modes

The following speed modes are available here:

Off: There is no speed control. The connected pump is only switched on or off with full speed.

Mode M1: After the purging time the controller switches to the set max. speed. If the temperature difference ΔT between the reference sensors (collector and storage tank) is less than the set value, then the speed is decreased by one stage after the control time elapses. If the temperature difference between the reference sensors is greater than the set value, then the speed is increased by one stage after the control time elapses. If the controller has adjusted the speed of the pump down to the smallest stage and the ΔT between the reference sensors is ΔT_{off} , the pump is switched off.

Mode M2: After the purging time the controller switches to the set min. speed. If the temperature difference ΔT between the reference sensors (collector and storage tank) is greater than the set value, then the speed is increased by one stage after the control time elapses. If the temperature difference ΔT between the reference sensors is below the set value, then the speed is decreased by one stage after the control time elapses. If the controller has adjusted the speed of the pump down to the smallest stage and the ΔT between the reference sensors is $T\Delta_{off}$, the pump is switched off.

Mode M3: After the purging time the controller switches to the set min. speed. If the temperature at the reference sensor (collector) is greater than the setpoint to be set subsequently, then the speed is increased by one stage after the control time expires. If the temperature at the reference sensor (collector) is less than the setpoint to be set subsequently, then the speed is decreased by one stage after the control time expires.

Mode M4:

When the primary storage is loaded, speed control works as in M3.

When the secondary storage is loaded, speed control works as in M2.

Settings range: M1, M2, M3, M4, Off / Default: Off

6.3.2. - Purging time

During this time period, the pump is running with full speed (100%) to ensure trouble-free startup. After this time has passed, the pump is set to speed control and is set to max. speed or min speed, depending on the speed control variant „6.3.1. - Modes“ on page 31 chosen. Purging time can not be applied with PWM or 0-10V output.

Settings range: 5 to 600 seconds / Default setting: 8 seconds

6.3.3. - Sweep time

Sweep time determines the inertia of the speed control to prevent strong fluctuations in temperature.

Sweep time is the timespan for a complete change from minimum to maximum pump speed.

Settings range: 1 to 15 minutes / Default setting: 4 minutes

Special functions

6.3.4. - max. speed

The maximum speed of the pump is specified here. During the setting the pump runs at the specified speed and the flow rate can be determined.

Settings range: 70% to 100% / Default setting: 100%



Caution

The indicated percentages are guide values that may vary to a greater or lesser extent depending on the system, pump and pump stage.

6.3.5. - min. speed

The minimum speed of the pump at relay R1 is specified here. During the setting the pump runs at the specified speed and the flow rate can be determined.

Settings range: (Speed from „J.14.6. - Speed when „On““ on page 53) to max. speed -5% / Default setting: 30%



Caution

The indicated percentages are guide values that may vary to a greater or lesser extent depending on the system, pump and pump stage.. 100% is the maximum possible voltage/frequency of the controller.

6.3.6. - Setpoint

This value is the control setpoint for Mode 3 (see „6.3.1. - Modes“ on page 31). If the value at the collector sensor drops below this, the speed is reduced. If it rises above this, the speed is increased.

Settings range: 0° to 90°C / Default setting: 60°C



Special functions

6.4. - Relay functions

The here explained additional functions can be assigned to unused relays. Every additional function can only be used once. Pay special attention to the technical data of the relays („B.1. - Specifications“ on page 6).

The enumeration does not correspond to the controllers menu enumeration.

Examples:

System 1 +  + 

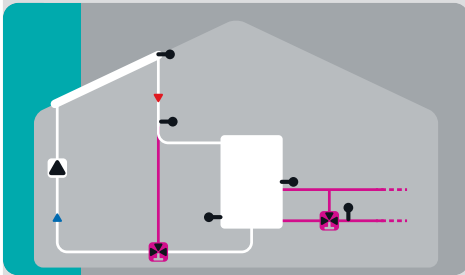

Solar with storage
with additional functions Solar
Bypass
and Return Flow Increase

System 14 + 

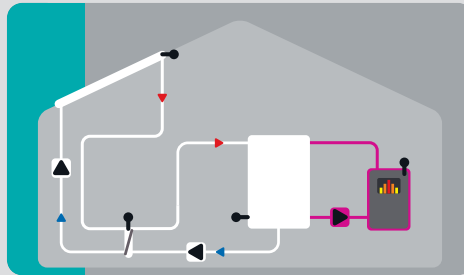

Solar with heat exchanger
with additional function Solid Fuel
Boiler

System 11 + 

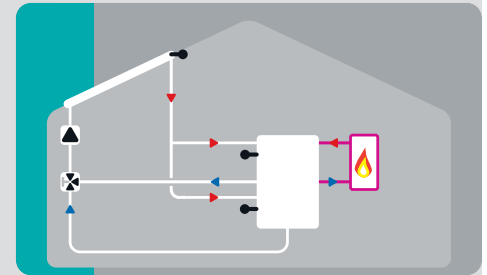

Solar with 2 zone storage and
switching valve
with additional function Thermostat

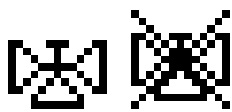

Relay functions

6.4.1. - Solar bypass

Use the relay to switch a bypass valve or a bypass pump

This can direct the flow pass the storage, when the flow temperature at the bypass sensor is lower than the storage that has to be charged.

Settings range: On; Off

6.4.1.1. - Variant

This menu determines whether a pump or valve is used to direct the flow through the bypass.

Settings range: Pump, Valve / Default setting: Valve

6.4.1.2. - Bypass (sensor)

The flow sensor for the bypass function is selected in this menu. Do not install in the return flow.

Settings range: S1-S8, VFS1, VFS2 / Default setting: none

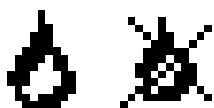

6.4.2. - Thermostat

Thermostat is used for time- and temperature controlled additional heating.

Settings range: On, Off, Inverted



Temperature values which are set too high can lead to scalding or damage to the system. Scalding protection must be provided by the customer!



In Energy savings mode, different settings may apply, see e.g. T eco.

6.4.2.1. - TH Set

Target temperature at thermostat sensor 1. Below this temperature, additional heating is switched on, till TH set + hysteresis is reached.

Settings range: 0-100°C / Default setting: 50

6.4.2.2. - TH hysteresis

Hysteresis of setpoint temperature.

Settings range: -20 to +20K / Default setting: 10K

6.4.2.3. - Thermostat sensor 1

T set is measured with thermostat sensor 1.

When thermostat sensor 2 is connected, the relay switches on when T set is undershot at thermostat Sensor 1, and switches off when T set + hysteresis at thermostat sensor 2 is exceeded.

Settings range: S1-S8, VFS1-2, active storage / Default setting: none

6.4.2.4. - Thermostat sensor 2

Optional switch off sensor

When T set + hysteresis is exceeded at the optional thermostat sensor 2, the relay is switched off.

Settings range: S1-S8, VFS1-2, active storage / Default setting: none

6.4.2.5. - T eco

For Energy saving mode

When Energy saving mode is active: During solar charge T eco is used instead of TH set. When the temperature drops below T eco at thermostat sensor 1, the relay is switched on and heats up to T eco + hysteresis.

Settings range: 0-100°C / Default setting: 40°C

6.4.1.3. - Storage

For Energy saving mode

Loading this storage activates the Energy saving mode

When this storage is charge by solar, additional heating is only switched on when the temperature is below T eco.

Settings range: (Storage sensors) / Default setting: first storage

Special functions

6.4.3.1. - Energy saving mode

Energy saving mode switches the heating on when T eco is undershot und heats up to T eco + hysteresis when solar charge is active.

Settings range: On, Off / Default setting: Off

6.4.3.2. - Periods

Thermostat activity times

Set the desired periods of time when the thermostat should be active. 3 periods can be set per day, settings can also be copied to other days. Outside the set times the thermostat is switched off.

Setting range: from 00:00 to 23:59 /default setting: 06:00 to 22:00

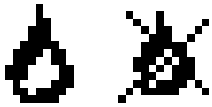

6.4.3. - Thermostat 2

Thermostat is used for time- and temperature controlled additional heating.
See Thermostat 1



6.4.4. - Cooling

This is used to cool down e.g. storages to a setpoint temperature by radiating heat.

Settings range: S1-S8, VFS1-2, active Storage / Default setting: None

6.4.4.1. - Co T set

Target temperature at thermostat sensor 1. Cooling is on above this temperature till Co T set + hysteresis is reached.

Settings range: 0-100°C / Default setting: 50°C

6.4.4.2. - Co hysteresis

If the temperature at th drops below Co T set + hysteresis, the relay is switched off.

Settings range: 0-100 / Default setting: 40

6.4.4.3. - Cooling (sensor)

Reference sensor of the cooling function.

Settings range: (Storage sensor) / Default setting: First storage

6.4.4.4. - Periods

Cooling activity times

Set the desired periods of time when the cooling should be active. 3 periods can be set per day, settings can also be copied to other days. Outside the set times the cooling function is switched off.

Setting range: from 00:00 to 23:59 /default setting: 06:00 to 22:00

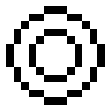

6.4.5. - Return flow increase

This function is used to raise the temperature of e.g. the return flow by the storage.

Settings range: On, Off

6.4.5.1. - RF Tmax

Maximum temperature at the return flow sensor. If this temperature is exceeded, the relay is switched off.

Settings range: 0-80°C / Default setting: 70°C

6.4.5.2. - ΔT return flow

Switch-on temperature difference:

When this difference is exceeded between return flow sensor and storage sensor, the relay is switched on.

Settings range: 5-20 K / Default setting: 8 K

Switch-off temperature difference:

When this difference is exceeded between return flow sensor and storage sensor, the relay is switched off.

Settings range: 2-19 K (limited by ΔT Storage RF On) / Default setting: 4 K

6.4.5.3. - Return flow (sensor)

Determines the sensor for return flow increase.

Settings range: S1-S8, VFS1-2, active Storage / Default setting: none

6.4.5.4. - Storage (sensor)

Determines the storage sensor

Settings range: S1-S8, VFS1-2, active Storage / Default setting: none



6.4.6. - Collector field cooling

This function controls an external cooling unit to cool down the collector.

Settings range: On, Off

6.4.6.1. - Tmax field

If this temperature is exceeded at the reference sensor, the relay is switched on.

Settings range: 100 °C to 180 °C / Default: 120 °C

6.4.6.2. - Hys min

When the temperature falls below Tmax field +Hys min, the relay is switched off.

Settings range: -20 to -2 °C / Default: -5

6.4.6.3. - Hys max

To protect the cooling unit itself from damage, the relay is switched off as soon as the temperature at the reference sensor reaches Tmax field + Hys max

Settings range: 2 to 60 °C / Default: -20

6.4.6.4. - Field cooling sensor

Reference sensor of the collector field cooling function.

Settings range: S1-S8, VFS1-2, active storage, RC / Default: none



Caution

This function does not activate the solar pump to cool the collector. Therefore, please refer to the collector protection.



6.4.7. - Anti Legionella

This function is used to heat up the system during selected periods to eliminate legionella bacteria.

Settings range: S1-S8, VFS1-2, Active storage/ Default setting: none

6.4.7.1. - AL T set

This temperature has to be detected for the time set in AL residence time at the AL sensors for a successful heat up.

Settings range: 60-99 °C / Default setting: 70°C

6.4.7.2. - AL residence time

This determines the time span for which the AL T set temperature must be detected for a successful AL heat up.

Settings range: 1-120 min / Default setting: 60 min

6.4.7.3. - Last AL heat

This displays the date and time of the last successful heat up.

No settings

6.4.7.4. - AL sensor 1

This temperature is used to measure the AL temperature.

Settings range: S1-S8, VFS1-2, Active storage/ Default setting: none

6.4.7.5. - AL Sensor 2

Optional AL sensor

When a second sensor is connected, both sensors must reach and hold the setpoint temperature for the residence time for a successful heat up.

Settings range: S1-S8, VFS1-2, Active storage/ Default setting: none

6.4.7.6. - AL-times

During this periods the AL heat up is attempted.

Setting range: from 00:00 to 23:59 / default setting: 06:00 to 22:00



Caution

This anti-Legionella function does not provide complete protection against Legionella, because the controller is dependent on sufficient energy being fed in, and it is not possible to monitor the temperatures in the entire range of the storage tanks and the connected piping system. To provide complete protection against Legionella bacteria, it must be ensured that the temperature is raised to the necessary temperature, and at the same time there must be water circulation in the storage tank and piping system by means of other additional energy sources and external control units.



Caution

The anti-Legionella function is switched off at delivery. Whenever heating-up has been carried out with the anti-Legionella function switched on, an information message with the date appears on the display.



Danger

During the anti-Legionella function the storage tank is heated up over the set value "Tmax S(X)", which can lead to scalding and damage to the system.

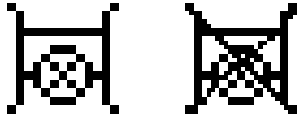

6.4.8. - Heat transfer

This is used to transfer energy from one storage to another with a pump.
Settings range: S1-S8, VFS1-2, Active storage/ Default setting: none

6.4.8.1. - ΔT Heat transfer

Temperature difference for heat transfer function.

When the temperature difference between HT Source and HT Drain reaches ΔT Heat Transfer On, the relay is switched on. As soon as the difference drops to ΔT Heat Transfer Off, the relay is switched off again.

On: Settings range: 5-20 K/ Default setting: 8 K

Off: Settings range: 2 K to ΔT Ein / Default setting: 4 K

6.4.8.2. - Setpoint

Setpoint temperature of the target storage

When this temperature is detected in the target storage, heat transfer is switched off.

Settings range: 0-90 °C / Default setting: 60°C

6.4.8.3. - HT Tmin

Minimum temperature in source storage to enable the heat transfer

Settings range: 0-90 °C / Default setting: 30°C

6.4.8.4. - HT Source (sensor)

This menu determines the sensor, that is placed in the source storage.

Settings range: S1-S8, VFS1-2, Active storage/ Default setting: none

6.4.8.5. - HT Drain (Target sensor)

This determines the sensor placed in the storage that is receiving energy from the source storage.

Settings range: S1-S8, VFS1-2, Active storage/ Default setting: none

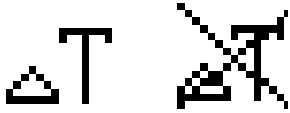

6.4.9. - Difference

The relay is switched on when a specific temperature difference (ΔT) is reached.

Settings range: On, Off

6.4.9.1. - ΔT difference

Switch on - difference:

When this temperature difference is reached, the relay is switched on.

Settings range: 5-20° C / Default setting: 8° C

Switch off - difference:

When this temperature difference is reached, the relay is switched off.

Settings range: 2-19° C / Default setting: 4° C (the upper limit is the switch on - difference)

6.4.9.2. - DF source (sensor)

Heat source sensor for Difference function

This determines the sensor for the heat source.

Settings range: S1-S8, VFS1-2, Active storage/ Default setting: none

6.4.9.3. - Diff Tmin

Minimum temperature at source sensor to enable the difference relay

When the temperature at the source sensor is below this level, the difference function is disabled.

Settings range: 0 to 90°C / Default setting: 20°C

6.4.9.4. - DF Drain (sensor)

Drain sensor / Target sensor for difference function

This determines the sensor for the target storage.

Settings range: S1-S8, VFS1-2, Active storage/ Default setting: none

6.4.9.5. - DF Tmax

Maximum temperature at target sensor to enable difference function

If the temperature at the target sensor exceeds this value, difference function is disabled.

Settings range: 0 to 99°C / Default setting: 60°C

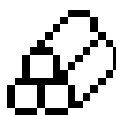

6.4.10. - Solid fuel boiler

The relay is used to control an additional solid fuel boiler.

Settings range: On, Off

6.4.10.1. - SF Tmin

Minimum temperature in the solid fuel boiler to switch on the pump. If the temperature at the boiler sensor is below this temperature, the relay is disabled.

Settings range: 0 ° C to 100° C / Default setting: 70° C

6.4.10.2. - ΔT Solid fuel

Switch on and Switch off condition for the temperature difference between boiler and storage.

Switch on difference ΔT SF

Settings range: 5 to 20 K / Default setting: 8

Switch off temperature difference ΔT SF

Settings range: 0 K to Switch ΔT SF / Default setting: 7

6.4.10.3. - SF Tmax

Maximum temperature in the storage. If this is exceeded, the relay is switched off.

Settings range: Off to 100°C / Default setting: 70° C

6.4.10.4. - Boiler sensor

This determines the sensor, that is used as boiler sensor.

Settings range: S1-S8, VFS1-2, Active storage/ Default setting: none

6.4.10.5. - Storage sensor

This determines the sensor, that is used as storage sensor.

Settings range: S1-S8, VFS1-2, Active storage/ Default setting: none



6.4.11. - Error message

The relay is switched on, when one or more protective function is active or a message is shown. This function can be inverted, so that the relay is always on and switches off when a protective function or a message is shown.

Settings range: On, Inverted, Off / Default setting: Off

Collector protection

System protection

Frost protection

Recooling

Antilegionella protection

Message

Collector alarm



6.4.12. - Pressure monitor

The relay is switched on when the pressure drops below set minimum or exceeds the set maximum pressure.

Settings range: On, Off / Default setting: Off

6.4.12.1. - Pressure monitor

This menu is used to configure the system pressure monitoring via direct sensor. As soon as the set limits are exceeded, the relay is switched on.

6.4.12.2. - RPS1 / RPS2

Type of pressure sensor

This menu is used to determine the type of pressure sensor used.

Please note: If e.g. VFS1 is connected, RPS1 option is not shown.

Settings range: Off; 0-0,6 bar; 0-1 bar; 0-1,6 bar; 0-2,5 bar; 0-4 bar; 0-6 bar; 0-10 bar

Default setting: Off

6.4.12.3. - Pmin

Minimum pressure. If this value is undershot, an error message is displayed and the relay is switched on.

Settings range: Off; 0,0 to 1,6 bar

Default setting:

6.4.12.4. - Pmax

Maximum pressure. If this value is exceeded, an error message is displayed and the relay is switched on.

Settings range: Off; 0,0 to 10 bar

Default setting: 1,6 bar

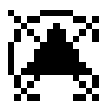

6.4.13. - Booster pump

Additional pump that fills the system at the start of every solar charge.

Settings range: S1-S8, VFS1-2, Active storage / Default setting: none

6.4.13.1. - Filling time

Time the pump is switched on

This setting determines the length of time the pump is switched on at the start of a solar charge.

Settings range: 0-120 seconds / Default setting: 30 seconds



6.4.14. - Parallel operation R (X)

The relay is switched on at the same time as the set relay R1 or R2.

Settings range: On, Off, Inverted

6.4.14.1. - Delay

This menu determines how long after the start of R1 or R2 the parallel relay is switched on.

Settings range: 0-120 seconds / Default setting: 30 seconds

6.4.14.2. - Followup time

This menu determines how long after the switch off of R1 or R2 the parallel relay is switched off.

Settings range: 0-120 seconds / Default setting: 30 seconds

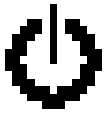

6.4.15. - Always on

Relay is always switched on.

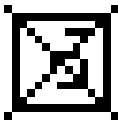
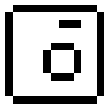

6.4.16. - Heating circuit

Heat circuit pump is controlled with a fixed hysteresis of $(\pm 1^\circ)$ for setpoint temperature).

30 seconds Switch on and Switch off delay is fixed setting to prevent unnecessary switching of the pump.

RC21 room controller can be used as room temperature sensor.

Settings range: On, Off

6.4.16.1. - Room set day

Room reference temperature in day mode. If this temperature is exceeded at the room temperature sensor at the set times, the relay is switched off.

Settings range: 10 to 30° C

6.4.16.2. - Room set night

Room reference temperature in night mode. If this temperature is exceeded at the room temperature sensor at the set times, the relay is switched off.

Settings range: 10 to 30° C

6.4.16.3. - Room sensor

This menu determines the sensor for the room temperature.

Settings range: S2 to S7, RC

6.4.16.4. - Periods

Set the desired periods of time when the heat circuit day mode should be active. 3 periods can be set per day, settings can also be copied to other days. Outside the set times the heating function is working in night mode.

Setting range: from 00:00 to 23:59 /default setting: 06:00 to 22:00

6.5. - Heat quantity

6.5.1. - Constant flow

When the heat meter mode „Flow rate“ is selected, an approximated heat quantity is calculated using the values the user has to enter. These are type of glycol/AntiFreeze, glycol portion and flow rate. These values are put into correlation with the temperature data of collector sensor and storage sensor. If necessary a correction value for ΔT can be set: Since for the heat meter the collector and the storage temperature are used, a difference to the flow respectively return flow temperature can be compensated by changing Offset ΔT accordingly.

Example:

Displayed collector temp. 40°C, measured flow temperature 39°C, displayed storage temperature 30°C, measured return temperature 31°C = results in a correction value of -20% (displayed ΔT 10K, real ΔT 8K = -20% correction)



Caution

The heat quantity measured in the mode “Flow rate” is a calculated approximation for function control of the system.

6.5.1.1. - Flow sensor (X)

This determines the sensor that is used to measure the flow temperature.

Settings range: S1-S8, VFS1-2, active collector, active storage/ Default setting: S1

6.5.1.2. - Return sensor

This determines the sensor that is used to measure the return temperature.

Settings range: S1-S8, VFS1-2, Aktiver Collector, Active storage/ Default setting: S2

6.5.1.3. - Anti freeze type

Set the type of anti freeze used. If none is used, please set to 0.

Settings range: Ethylen, Propylen / Default setting: Propylen

6.5.1.4. - Glycole percentage

The amount of anti freeze agent in the system.

Settings range: 0-100% / Default setting: 45%

6.5.1.5. - Flow rate (X)

Flow rate that is used to calculate the heat quantity

This determines the flow rate in litres per minute that is used for the calculation of the heat quantity.

Settings range: 0-100 l/min / Default setting: 5 l/min

6.5.1.6. - Offset ΔT

Correction value for temperature difference

Since for the heat meter the collector and the storage temperature are used, a difference to the flow respectively return flow temperature can be compensated by changing Offset ΔT accordingly.

Example:

Displayed collector temp. 40°C, measured flow temperature 39°C, displayed storage temperature 30°C, measured return temperature 31°C = results in a correction value of -20% (displayed ΔT 10K, real ΔT 8K = -20% correction)

Settings range: -50 to +50% / Default setting: 0%

Special functions

6.5.2. - VFS (X)

6.5.2.1. - VFS Typ

The VFS type is set here.

Settings range: Off; 1-12; 1-20; 2-40; 5-100; 10-200; 20-400 / Default setting: Off

6.5.2.2. - VFS - Position

This setting determines the position of the VFS sensor.

Settings range: flow, return / Default setting: return



To prevent damage to the Vortex Flow Sensor it is strongly recommended to install it into the return flow. If it is necessary to install in the flow, it is imperative not to exceed the maximum temperatures of the sensor! (0° C to 100°C and -25°C to 120°C short term)

6.5.2.3. - Reference sensor

The reference sensor used for the heat metering is set here.

Settings range: S1-S8, VFS1-2, active collector, active storage/ Default setting: S6

6.6. - Pressure monitor

A message is shown when the pressure drops below set minimum or exceeds the set maximum pressure. No relay is switched, for that see „6.4.12. - Pressure monitor“ on page 43.

6.6.1. - Pressure monitor

A message is shown and the LED flashes when the pressure deviates from the set minimum or maximum value.

Settings range: On, Off / Default setting: Off

6.6.1.1. - RPS1 / RPS2

Type of pressure sensor

This menu is used to determine the type of pressure sensor used.

Please note: If e.g. VFS1 is connected, RPS1 option is not shown.

Settings range: Off; 0-0.6 bar; 0-1 bar; 0-1.6 bar; 0-2.5 bar; 0-4 bar; 0-6 bar; 0-10 bar

Default setting: Off

6.6.1.2. - Pmin

Minimum pressure.

If this value is undershot, an error message is displayed and the relay is switched on.

Settings range: Off; 0,0 to 1.6 bar

Default setting: 0,0

6.6.1.3. - Pmax

Maximum pressure.

If this value is exceeded, an error message is displayed and the relay is switched on.

Settings range: Off; 0,0 to 10 bar

Default setting: Maximumvalue of the sensor

Special functions

6.7. - Sensor calibration

Deviations in the temperature values displayed, for example due to cables which are too long or sensors which are not positioned optimally, can be compensated for manually here. The settings can be made for each individual sensor in steps of 0.8°C (temperature) resp. 0.2% of the measuring range of the VFS / RPS sensor (flow rate / pressure) per step.

Offset Sensor Settings range: -100 ... +100 / Default setting: 0



Caution

Settings sind nur in Sonderfällen bei Erstinbetriebnahme durch den Fachmann nötig. Falsche Messwerte können zu Fehlfunktionen führen.

6.8. - Commissioning

Starting the commissioning help guides you in the correct order through the basic settings necessary for commissioning, and provides brief descriptions of each parameter in the display.

Pressing the “esc” key takes you back to the previous value so you can look at the selected setting again or adjust it if desired. Pressing the “esc” more than once takes you back to the selection mode, thus cancelling the commissioning help.



Caution

May only be started by a specialist during commissioning! Observe the explanations for the individual parameters in these instructions, and check whether further settings are necessary for your application.

6.9. - Factory settings

All of the settings that have been made can be reset, thus returning the controller to its delivery state.



Caution

The entire parametrisation, analyses, etc. of the controller will be lost irrevocably. The controller must then be commissioned once again.

6.10. - Start aid function

With some solar systems, especially with vacuum tube collectors, it may occur that the measurement value acquisition at the collector sensor occurs too slowly or too inaccurately because the sensor is often not at the hottest location. When the start help is activated the following sequence is carried out:

If the temperature at the collector sensor increases by the value specified under “Increase” within one minute, then the solar pump is switched on for the set “Purging time” so that the medium to be measured can be moved to the collector sensor. If this still does not result in a normal switch-on condition, then the start help function is subject to a 5-minute lockout time.

Start help setting range: on, off/default setting: off

Purging time setting range: 2 ... 30 sec./default setting: 5 sec.

Increase setting range: 1°C...10°C/default setting: 3°C/min.



Caution

This function should only be activated by a specialist if problems arise with acquisition of measurement values. In particular follow the instructions from the collector manufacturer.

Special functions

6.11. - Time and date

This menu is used to set the current time and date.



Caution

For analysis of the system data it is essential for the time to be set accurately on the controller. Please note that the clock does not continue to run if the mains voltage is interrupted, and must therefore be reset.

6.12. - Daylight saving time

When this function is active, the controller's clock changes automatically to and from DST (DST, Daylight Savings Time).

Default: On

6.13. - Sleep mode

When active, the displays backlight is switched off after 2 minutes of inactivity.

Voreinstellung: Aus



Caution

If a message is waiting, the backlight is not switched off.

6.14. - Temperature unit

This menu is used to select the temperature unit that is displayed.

Settings range: °F or °C / Default: °C

Menu lock, Service values, languages

7. - Menu lock



Menu “7. Menu lock” can be used to secure the controller against unintentional changing of the set values.

The menu is closed by pressing “esc” or selecting “Exit menu lock”.

The menus listed below remain completely accessible despite the menu lock being activated, and can be used to make adjustments if necessary:

1. Measurement values
2. Statistics
- 6.23. Time&date
7. Menu lock
8. Service values

To lock the other menus, select “Menu lock on”.

To enable the menus again, select “Menu lock off”.

Setting range: on, off/default setting: off

8. - Service values

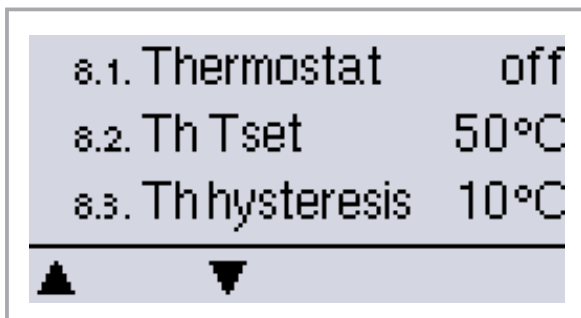

The menu „8. - Service values“ can be used for remote diagnosis by a specialist or the manufacturer in the event of an error, etc.

9. - Languages



Menu “9. Language” can be used to select the language for the menu guidance. This is queried automatically during initial commissioning.

The choice of languages may differ, however, depending on the device design.

Malfunctions

Z.1. Malfunctions with error messages

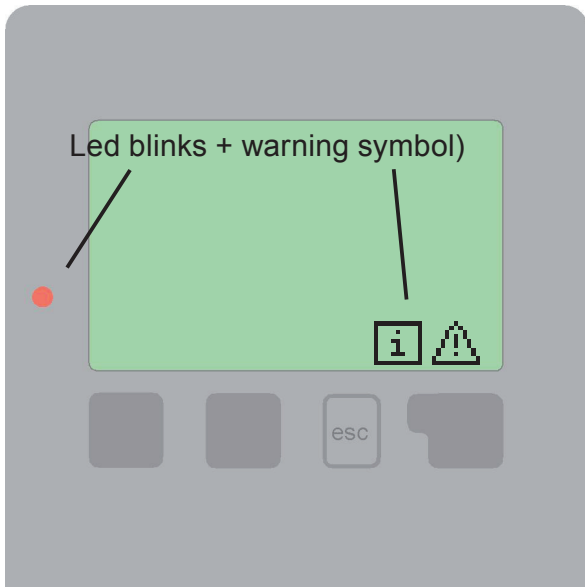

If the controller detects a malfunction, the red light flashes and the warning symbol also appears in the display. If the error is no longer present, the warning symbol changes to an info symbol and the red light no longer flashes.

To obtain more detailed information on the error, press the key under the warning or info symbol.



Do not try to deal with this yourself.
Consult a specialist in the event of an error!

Possible error messages:

Notes for the specialist:

Sensor x defective

Means that either the sensor, the sensor input at the controller or the connecting cable is/was defective.
(Resistance table see „B.2. - Temperature resistance table for Pt1000 sensors“ on page 7)

Collector alarm

Means that the collector has fallen/fell below the temperature set under menu „5.6. - Collector alarm“ on page 29

Restart

Means that the controller was restarted, for example due to a power failure. Check the date&time!

Time & Date

This message appears automatically after a mains failure because the time&date have to be checked, and reset if necessary.

No flow

Is displayed when ΔT between storage and collector is 50° or higher for 5 minutes without interruption.

Frequent on / off

A relay was switched on and off more than 5 times within 5 minutes.

AL failed

Is displayed when AL ref- 5°C was not measured for the set AI residence time at the AL sensor.

Malfunctions

Z.2 Replacing the fuse



Repairs and maintenance may only be performed by a specialist. Before working on the unit switch off the power supply and secure it against being switched on again! Check for the absence of power!



Only use the supplied spare fuse or fuses of the same design with the following specifications: T2A / 250V .

If the mains voltage is switched on and the controller still does not function or display anything, then the internal device fuse may be defective. In that case, open the device as described under C, remove the old fuse and check it. Exchange the defective fuse for a new one, locate the external source of the error (e.g. pump) and exchange it. Then first recommission the controller and check the function of the switch outputs in manual mode as described under „3.2. - Manual“ on page 24

Z.2.1

Fuse

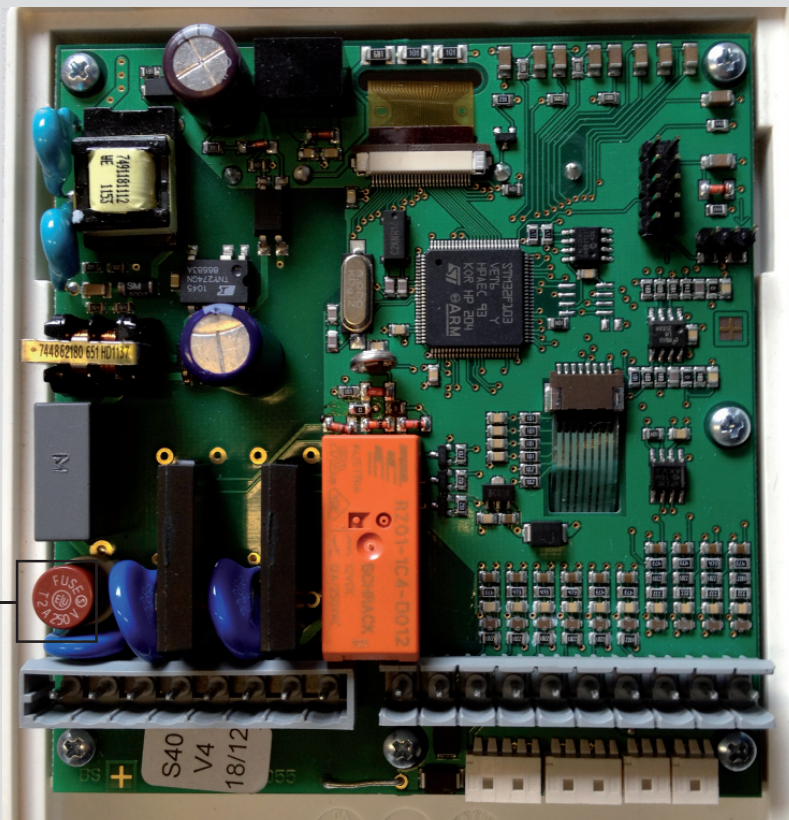

Z.3 Maintenance



Caution

In the course of the general annual maintenance of your heating system you should also have the functions of the controller checked by a specialist and have the settings optimised if necessary.

Performing maintenance:

- Check the date and time (see „6.11. - Time and date“ on page 48)
- Assess/check plausibility of analyses (see „2. - Statistics“ on page 23)
- Check the error memory (see „2.4. - Message log“ on page 23)
- Verify/check plausibility of the current measurement values (see „1. - Measurement values“ on page 22)
- Check the switch outputs/consumers in manual mode (see „3.2. - Manual“ on page 24)
- Possibly optimise the parameter settings

Appendix Manual pump settings

J. - Appendix

Manual pump settings (see „6.2. - Pump menu“ on page 30)

J.14.1. - Pump

In this menu, preconfigured profiles for various pumps can be selected. Please note that individual settings are still possible even when a profile has been selected.

J.14.2. - Output Signal

This menu determines the type of pump used: Solar pumps perform at their highest power when the signal is also maxed, heating pump on the other hand are set to highest power wenn the control signal is at the lowest. Solar = normal, heating = Inverted.

Settings range: Normal, Inverted / Default setting: Normal

J.14.3. - PWM off

This signal is put out when the pump is switched off (Pumps that can detect cable break need a minimum signal).

Settings range: (Solar:) 0 to 50% / Default setting: 0% - (Heating:) 50% to 100% / Default setting: 100%

J.14.4. - PWM on

This signal is needed to turn the pump on at minimum speed.

Settings range: (Solar:) 0 to 50% / Default setting: 10% - (Heating:) 50% to 100% / Default setting: 90%

J.14.5. - PWM Max

This determines the the output signal for the highest speed of the pump, that is used e.g. during purging or manual operation.

Settings range: (Solar:) 50 to 100% / Default setting: 100% - (Heating:) 0% to 50% / Default setting: 0%

J.17.3 - 0-10V off

This voltage is put out when the pump is turned off (Pumps that can detect cable break need a minimum voltage).

Settings range: (Solar:) 0,0 to 5,0 V / Default setting: 1,0 V - (Heating:) 5,0 to 0,0 V / Default setting: 4 ,0 V

J.17.4 - 0-10V on

This voltage is needed to turn the pump on at minimum speed.

Settings range: (Solar:) 0,0 to 5,0 V / Default setting: 1,0 V - (Heating:) 5,0 to 10,0 V / Default setting: 9,0 V

J.17.5 - 0-10V Max

This determines the output voltage for the highest speed of the pump, that is used e.g. during purging or manual operation

Settings range: (Solar:) 5,0 to 10,0 V / Default setting: 10,0 V - (Heating:) 0,0 to 5,0 V / Default setting: 0,0 V

J.14.6. - Speed when „On“

This menu determines the calculated and displayed speed of the pump. If e.g. 30% is set here and the signal set in „PWM on/0-10V on“ is put out, 30% speed is displayed. When the signal set in „PWM max/0-10V max“ is put out, 100% speed is displayed. Everything in between is calculated accordingly.

Settings range: 10 to 90 % / Default setting: 30 %



Caution

This function has no influence on the regulation, but changes only the speed displayed.

J.14.7. - Show signal

Displays the set signal in text and a graphical diagram.

Appendix Manual pump settings

J.2.3a Example for pump settings

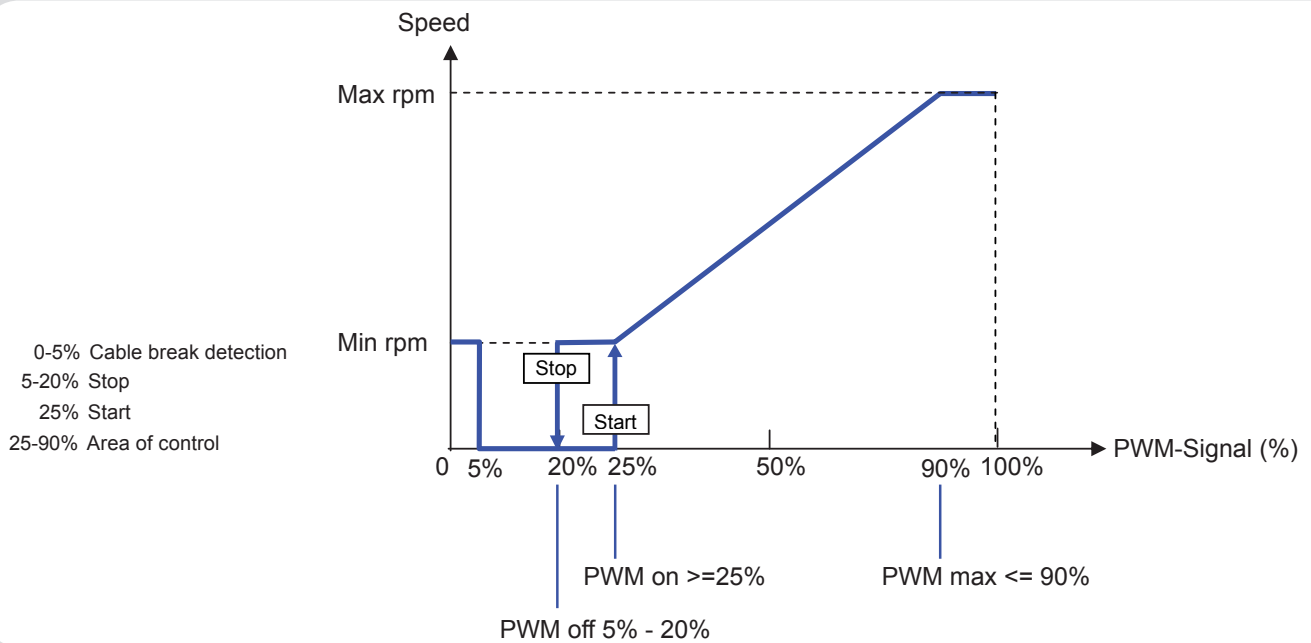

J.2.3b Technical data PWM and 0-10V

Technical data PWM:

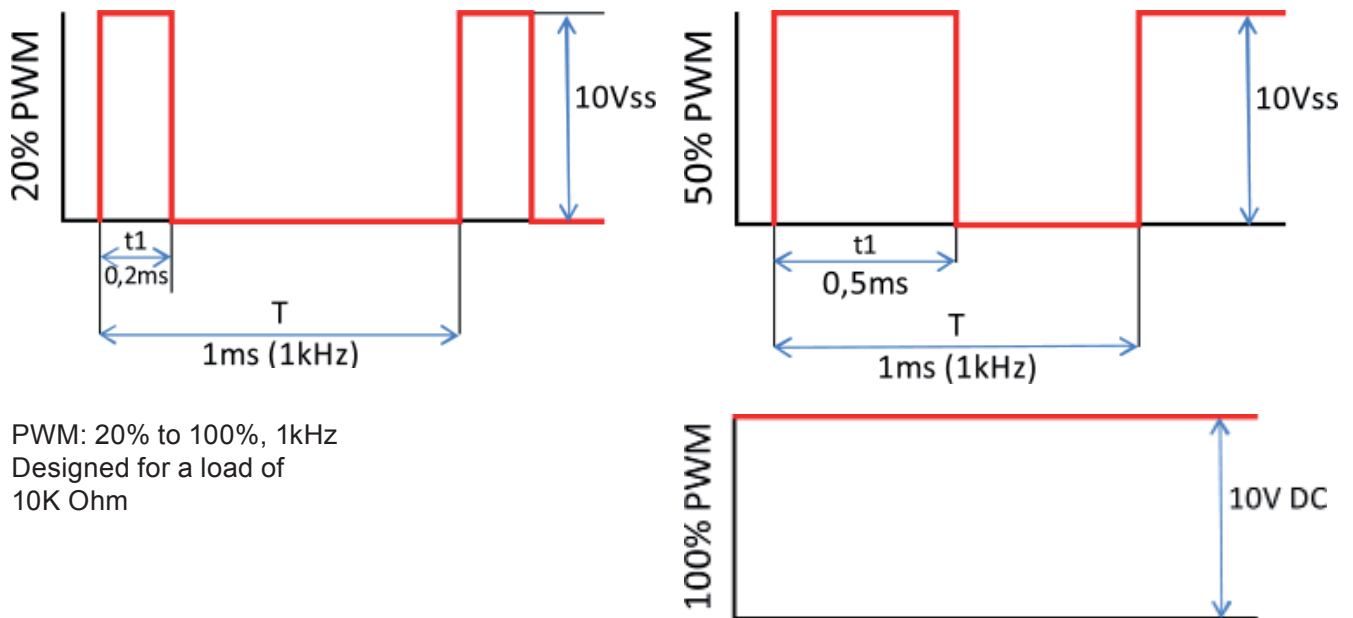

PWM: 20% to 100%, 1kHz
 Designed for a load of
 10K Ohm

Technical data 0-10V:
 0-10V: 2V to 10V
 (20% to 100%)
 Designed for a load of
 10K Ohm.

10V = 100% Speed
 5V = 50% Speed
 2V = 20% Speed
 0V = Off

Useful notes/tips and tricks



Instead of setting the flow rate for the system using a flow rate limiter, it is better to adjust the flow rate using the switch on the pump and by means of the “max. speed” setting on the controller (see. „6.3.4. - max. speed“ on page 32). This saves electricity!



The service values (see „8. - Service values“ on page 49) include not only current measurement values and operating states, but also all of the settings for the controller. Write down the service values at least once after commissioning has been successfully completed.



In the event of uncertainty as to the control response or malfunctions the service values are a proven and successful method for remote diagnosis. Write down the service values (see „8. - Service values“ on page 49.) at the time that the suspected malfunction occurs. Send the service value table with a brief description of the error to the specialist or manufacturer.



In the programs with pool the charging of the pool, e.g. for winter operation, can be switched off using a simple function. To do this, simply press and hold the “esc” key down for several seconds on the diagram/overview screen. A message appears on the display as soon as the pool is switched off or when the pool is switched on again.



To protect against loss of data, record any analyses and data that are particularly important to you (see 2.) at regular intervals.

Hydraulic variant set:

Commissioned on:

Commissioned by:

Notes:

Your specialist dealer:

Atomthreads

Portions of the regulator firmware are Copyright (c) 2010, Kelvin Lawson. All rights reserved.

Redistribution and use in source and binary forms, with or without modification, are permitted provided that the following conditions are met:

1. Redistributions of source code must retain the above copyright notice, this list of conditions and the following disclaimer.
2. Redistributions in binary form must reproduce the above copyright notice, this list of conditions and the following disclaimer in the documentation and/or other materials provided with the distribution.
3. No personal names or organizations' names associated with the Atomthreads project may be used to endorse or promote products derived from this software without specific prior written permission.

THIS SOFTWARE IS PROVIDED BY THE ATOMTHREADS PROJECT AND CONTRIBUTORS „AS IS“ AND ANY EXPRESS OR IMPLIED WARRANTIES, INCLUDING, BUT NOT LIMITED TO, THE IMPLIED WARRANTIES OF MERCHANTABILITY AND FITNESS FOR A PARTICULAR PURPOSE ARE DISCLAIMED. IN NO EVENT SHALL THE PROJECT OR CONTRIBUTORS BE LIABLE FOR ANY DIRECT, INDIRECT, INCIDENTAL, SPECIAL, EXEMPLARY, OR CONSEQUENTIAL DAMAGES (INCLUDING, BUT NOT LIMITED TO, PROCUREMENT OF SUBSTITUTE GOODS OR SERVICES; LOSS OF USE, DATA, OR PROFITS; OR BUSINESS INTERRUPTION) HOWEVER CAUSED AND ON ANY THEORY OF LIABILITY, WHETHER IN CONTRACT, STRICT LIABILITY, OR TORT (INCLUDING NEGLIGENCE OR OTHERWISE) ARISING IN ANY WAY OUT OF THE USE OF THIS SOFTWARE, EVEN IF ADVISED OF THE POSSIBILITY OF SUCH DAMAGE.

Final declaration:

Although these instructions have been created with the greatest possible care, the possibility of incorrect or incomplete information cannot be excluded. Subject as a basic principle to errors and technical changes.

1340_31_Januar_2013

LWIP:

Portions of the regulator firmware are Copyright (c) 2001-2004 Swedish Institute of Computer Science. All rights reserved.

Redistribution and use in source and binary forms, with or without modification, are permitted provided that the following conditions are met:

1. Redistributions of source code must retain the above copyright notice, this list of conditions and the following disclaimer.
2. Redistributions in binary form must reproduce the above copyright notice, this list of conditions and the following disclaimer in the documentation and/or other materials provided with the distribution.
3. The name of the author may not be used to endorse or promote products derived from this software without specific prior written permission.

THIS SOFTWARE IS PROVIDED BY THE AUTHOR ``AS IS`` AND ANY EXPRESS OR IMPLIED WARRANTIES, INCLUDING, BUT NOT LIMITED TO, THE IMPLIED WARRANTIES OF MERCHANTABILITY AND FITNESS FOR A PARTICULAR PURPOSE ARE DISCLAIMED. IN NO EVENT SHALL THE AUTHOR BE LIABLE FOR ANY DIRECT, INDIRECT, INCIDENTAL, SPECIAL, EXEMPLARY, OR CONSEQUENTIAL DAMAGES (INCLUDING, BUT NOT LIMITED TO, PROCUREMENT OF SUBSTITUTE GOODS OR SERVICES; LOSS OF USE, DATA, OR PROFITS; OR BUSINESS INTERRUPTION) HOWEVER CAUSED AND ON ANY THEORY OF LIABILITY, WHETHER IN CONTRACT, STRICT LIABILITY, OR TORT (INCLUDING NEGLIGENCE OR OTHERWISE) ARISING IN ANY WAY OUT OF THE USE OF THIS SOFTWARE, EVEN IF ADVISED OF THE POSSIBILITY OF SUCH DAMAGE.